

**NIM MODEL 623 SERIES  
QUAD DISCRIMINATORS**

**March, 1983**

SECRET AND CONTROL UNIT  
ADMINISTRATIVE UNIT

SECRET CONTROL

## WARRANTY

LeCROY RESEARCH SYSTEMS CORP. warrants each instrument it manufactures to be free from defects in material and workmanship under normal use and service for the period of 1-year from date of purchase. Custom monolithics and hybrids sold separately and all spare or replacement parts are warranted for 90-days. This warranty extends only to the original purchaser. This warranty shall not apply to fuses, disposable batteries or any product or parts which have been subject to misuse, neglect, accident or abnormal conditions of operations.

In the event of failure of a product covered by this warranty, LeCroy will repair and calibrate an instrument returned to the factory or an authorized service facility within 1 year of the original purchase; provided the warrantor's examination discloses to its satisfaction that the product was defective. The warrantor may, at its option, replace the product in lieu of repair. With regard to any instrument returned within one year of the original purchase, said repairs or replacement will be made without charge. If the failure has been caused by misuse, neglect, accident or abnormal conditions or operations, repairs will be billed at a nominal cost. In such case, an estimate will be submitted before work is started, if requested.

The foregoing warranty is in lieu of all other warranties, express or implied, including but not limited to any implied warranty of merchantability, fitness or adequacy for any particular purpose or use. LeCroy Research Systems Corp., shall not be liable for any special, incidental or consequential damages, whether in contract, tort or otherwise.

IF ANY FAILURE OCCURS, notify LeCroy Research Systems Corp., or the nearest service facility, giving full details of the difficulty, and include the Model number, serial number, and FAN (Final Assembly Number) or ECO (Engineering Change Order) number. On receipt of this information, service data or shipping instructions will be forwarded to you. On receipt of the shipping instructions, forward the instrument, transportation prepaid. A Return Authorization number will be given as part of shipping instructions. Marking this RA number on the outside of the package will insure that it goes directly to the proper department within LeCroy. Repairs will be made at the service facility and the instrument returned, transportation prepaid.

ALL SHIPMENTS OF LECROY INSTRUMENTS FOR REPAIR OR ADJUSTMENT should be made via Air Freight or "Best Way" prepaid. The instrument should be shipped in the original packing carton; or if it is not available, use any suitable container that is rigid and of adequate size. If a substitute container is used, the instrument should be wrapped in paper and surrounded with at least four inches of excelsior or similar shock-absorbing material.

IN EVENT OF DAMAGE IN SHIPMENT to original purchaser the instrument should be thoroughly inspected immediately upon original delivery to purchaser. All material in the container should be checked against the enclosed packing list. The manufacturer will not be responsible for shortages against the packing sheet unless notified immediately. If the instrument is damaged in any way, a claim should be filed with the carrier immediately. (To obtain a quotation to repair shipment damage, contact the LeCroy factory or the nearest service facility).

DOCUMENTATION DISCREPANCIES OR OMISSIONS. LeCroy Research Systems is committed to providing unique, reliable, state-of-the-art instrumentation in the field of high-speed data acquisition and processing. Because of this commitment, the Engineering Department at LeCroy is continually refining and improving the performance of products. While the actual physical modifications or changes necessary to improve a model's operation can be implemented quite rapidly, the corrected documentation associated with the unit usually requires more time to produce. Consequently, this manual may not agree in every detail with the accompanying unit. There may be small discrepancies that were brought about by customer-prompted engineering changes or by changes determined during calibration in our Test Department. These differences usually are changes in the values of components for the purposes of pulse shape, timing, offset, etc., and only rarely include minor logic changes. Where any such inconsistencies exist, please be assured that the unit is correct and incorporates the most up-to-date circuitry. Whenever original discrepancies exist, fully updated documentation should be available upon your request within a month after your receipt of the unit.

ANY APPLICATION OR USE QUESTIONS, which will enhance your use of this instrument will be happily answered by a member of our Engineering Services Department, telephone 914-425-2000 or your local distributor. You may address any correspondence to:

LeCroy Research Systems Corp., 700 S. Main Street,  
Spring Valley, New York 10977, ATTN: Engineering Services Dept.

European Customers can contact:

LeCroy Research Systems Ltd.  
Elms Court  
Botley  
Oxford OX9 2LP England

LeCroy Research Systems SA  
81 Avenue Louis Casai  
1216 Cointrin-Geneva  
Switzerland

LeCroy Research Sys. S.a.r.l.  
Avenue Du Parana  
Z.A. De Courtaboeuf  
F-91940 Les Ulis, France

LeCroy Research Systems GmbH  
Treitschkestrasse 3  
Postfach 10 37 67  
69 Heidelberg  
West Germany

A T T E N T I O N

COMMON INHIBIT SHOULD PRECEDE ANALOG  
INPUT BY 6 NSEC (SEE SECTION 1.5).

MODULE SHOULD NOT BE PLUGGED IN WITH  
POWER ON.

SEE POCKET IN BACK OF MANUAL FOR  
SCHEMATICS, PARTS LISTS, AND ADDITIONAL  
ADDENDA WITH ANY CHANGES TO MANUAL.

A T T E N T I O N

1 0 1 0 0 0 0 0 0 0 0 0

0 0 0 0 0 0 0 0 0 0 0 0  
0 0 0 0 0 0 0 0 0 0 0 0

0 0 0 0 0 0 0 0 0 0 0 0  
0 0 0 0 0 0 0 0 0 0 0 0

0 0 0 0 0 0 0 0 0 0 0 0  
0 0 0 0 0 0 0 0 0 0 0 0  
0 0 0 0 0 0 0 0 0 0 0 0

1 0 1 0 0 0 0 0 0 0 0 0

## TABLE OF CONTENTS

	Page Number
<b>1 SPECIFICATIONS</b>	
1.1 Technical Data Sheet	
1.2 Front Panel Photograph with Callouts	
1.3 Input Characteristics	1-1
1.3.1 Threshold Range	1-1
1.3.2 Threshold Uncertainty	1-1
1.3.3 Threshold Memory	1-1
1.3.4 Threshold Calibration	1-2
1.3.5 623 Series Threshold Hysteresis	1-2
1.4 Input Reflections	1-2
1.5 Common Inhibit	1-3
1.6 Bridged High Impedance Input Factory Option	1-3
1.7 Output Characteristics	1-3
1.7.1 Output Width	1-4
1.7.2 Output Width Uncertainty	1-4
1.7.3 Updating	1-4
1.8 Timing Characteristics	1-4
1.8.1 Double-Pulse Resolution	1-4
1.8.2 Tracking Error	1-5
1.8.3 Slewing	1-5
1.9 Packaging	1-6
1.10 Current Requirements	1-6
1.11 Recommended Use of the NIM Power Bins	1-6
1.12 Input Protection	1-7
Figures for Section 1	
<b>2 TECHNICAL DESCRIPTION</b>	
2.1 General	2-1
2.2 Input and Discriminator	2-1
2.3 Timing Stage	2-2
2.4 Output Stage	2-2
2.5 Internal Power Supplies	2-2
Figures for Section 2	
<b>3 TEST AND CALIBRATION</b>	
3.1 Trouble Shooting	3-1
3.2 Required Recalibration if LD601's are Replaced	3-3

TABLE OF CONTENTS

Page No.

CONTENTS

1	Introduction	1
2	Objectives of the Study	2
3	Methodology	3
4	Results and Discussion	4
5	Conclusion	5
6	References	6
7	Appendix	7
8	Bibliography	8
9	Index	9
10	Summary	10
11	Abstract	11
12	Introduction	12
13	Methodology	13
14	Results and Discussion	14
15	Conclusion	15
16	References	16
17	Appendix	17
18	Bibliography	18
19	Index	19
20	Summary	20
21	Abstract	21
22	Introduction	22
23	Methodology	23
24	Results and Discussion	24
25	Conclusion	25
26	References	26
27	Appendix	27
28	Bibliography	28
29	Index	29
30	Summary	30
31	Abstract	31
32	Introduction	32
33	Methodology	33
34	Results and Discussion	34
35	Conclusion	35
36	References	36
37	Appendix	37
38	Bibliography	38
39	Index	39
40	Summary	40
41	Abstract	41
42	Introduction	42
43	Methodology	43
44	Results and Discussion	44
45	Conclusion	45
46	References	46
47	Appendix	47
48	Bibliography	48
49	Index	49
50	Summary	50
51	Abstract	51
52	Introduction	52
53	Methodology	53
54	Results and Discussion	54
55	Conclusion	55
56	References	56
57	Appendix	57
58	Bibliography	58
59	Index	59
60	Summary	60
61	Abstract	61
62	Introduction	62
63	Methodology	63
64	Results and Discussion	64
65	Conclusion	65
66	References	66
67	Appendix	67
68	Bibliography	68
69	Index	69
70	Summary	70
71	Abstract	71
72	Introduction	72
73	Methodology	73
74	Results and Discussion	74
75	Conclusion	75
76	References	76
77	Appendix	77
78	Bibliography	78
79	Index	79
80	Summary	80
81	Abstract	81
82	Introduction	82
83	Methodology	83
84	Results and Discussion	84
85	Conclusion	85
86	References	86
87	Appendix	87
88	Bibliography	88
89	Index	89
90	Summary	90
91	Abstract	91
92	Introduction	92
93	Methodology	93
94	Results and Discussion	94
95	Conclusion	95
96	References	96
97	Appendix	97
98	Bibliography	98
99	Index	99
100	Summary	100
101	Abstract	101
102	Introduction	102
103	Methodology	103
104	Results and Discussion	104
105	Conclusion	105
106	References	106
107	Appendix	107
108	Bibliography	108
109	Index	109
110	Summary	110
111	Abstract	111
112	Introduction	112
113	Methodology	113
114	Results and Discussion	114
115	Conclusion	115
116	References	116
117	Appendix	117
118	Bibliography	118
119	Index	119
120	Summary	120
121	Abstract	121
122	Introduction	122
123	Methodology	123
124	Results and Discussion	124
125	Conclusion	125
126	References	126
127	Appendix	127
128	Bibliography	128
129	Index	129
130	Summary	130
131	Abstract	131
132	Introduction	132
133	Methodology	133
134	Results and Discussion	134
135	Conclusion	135
136	References	136
137	Appendix	137
138	Bibliography	138
139	Index	139
140	Summary	140
141	Abstract	141
142	Introduction	142
143	Methodology	143
144	Results and Discussion	144
145	Conclusion	145
146	References	146
147	Appendix	147
148	Bibliography	148
149	Index	149
150	Summary	150
151	Abstract	151
152	Introduction	152
153	Methodology	153
154	Results and Discussion	154
155	Conclusion	155
156	References	156
157	Appendix	157
158	Bibliography	158
159	Index	159
160	Summary	160
161	Abstract	161
162	Introduction	162
163	Methodology	163
164	Results and Discussion	164
165	Conclusion	165
166	References	166
167	Appendix	167
168	Bibliography	168
169	Index	169
170	Summary	170
171	Abstract	171
172	Introduction	172
173	Methodology	173
174	Results and Discussion	174
175	Conclusion	175
176	References	176
177	Appendix	177
178	Bibliography	178
179	Index	179
180	Summary	180
181	Abstract	181
182	Introduction	182
183	Methodology	183
184	Results and Discussion	184
185	Conclusion	185
186	References	186
187	Appendix	187
188	Bibliography	188
189	Index	189
190	Summary	190
191	Abstract	191
192	Introduction	192
193	Methodology	193
194	Results and Discussion	194
195	Conclusion	195
196	References	196
197	Appendix	197
198	Bibliography	198
199	Index	199
200	Summary	200

TABLE OF CONTENTS

1	Introduction	1
2	Objectives of the Study	2
3	Methodology	3
4	Results and Discussion	4
5	Conclusion	5
6	References	6
7	Appendix	7
8	Bibliography	8
9	Index	9
10	Summary	10
11	Abstract	11
12	Introduction	12
13	Methodology	13
14	Results and Discussion	14
15	Conclusion	15
16	References	16
17	Appendix	17
18	Bibliography	18
19	Index	19
20	Summary	20
21	Abstract	21
22	Introduction	22
23	Methodology	23
24	Results and Discussion	24
25	Conclusion	25
26	References	26
27	Appendix	27
28	Bibliography	28
29	Index	29
30	Summary	30
31	Abstract	31
32	Introduction	32
33	Methodology	33
34	Results and Discussion	34
35	Conclusion	35
36	References	36
37	Appendix	37
38	Bibliography	38
39	Index	39
40	Summary	40
41	Abstract	41
42	Introduction	42
43	Methodology	43
44	Results and Discussion	44
45	Conclusion	45
46	References	46
47	Appendix	47
48	Bibliography	48
49	Index	49
50	Summary	50
51	Abstract	51
52	Introduction	52
53	Methodology	53
54	Results and Discussion	54
55	Conclusion	55
56	References	56
57	Appendix	57
58	Bibliography	58
59	Index	59
60	Summary	60
61	Abstract	61
62	Introduction	62
63	Methodology	63
64	Results and Discussion	64
65	Conclusion	65
66	References	66
67	Appendix	67
68	Bibliography	68
69	Index	69
70	Summary	70
71	Abstract	71
72	Introduction	72
73	Methodology	73
74	Results and Discussion	74
75	Conclusion	75
76	References	76
77	Appendix	77
78	Bibliography	78
79	Index	79
80	Summary	80
81	Abstract	81
82	Introduction	82
83	Methodology	83
84	Results and Discussion	84
85	Conclusion	85
86	References	86
87	Appendix	87
88	Bibliography	88
89	Index	89
90	Summary	90
91	Abstract	91
92	Introduction	92
93	Methodology	93
94	Results and Discussion	94
95	Conclusion	95
96	References	96
97	Appendix	97
98	Bibliography	98
99	Index	99
100	Summary	100

TABLE OF CONTENTS

1	Introduction	1
2	Objectives of the Study	2
3	Methodology	3
4	Results and Discussion	4
5	Conclusion	5
6	References	6
7	Appendix	7
8	Bibliography	8
9	Index	9
10	Summary	10
11	Abstract	11
12	Introduction	12
13	Methodology	13
14	Results and Discussion	14
15	Conclusion	15
16	References	16
17	Appendix	17
18	Bibliography	18
19	Index	19
20	Summary	20
21	Abstract	21
22	Introduction	22
23	Methodology	23
24	Results and Discussion	24
25	Conclusion	25
26	References	26
27	Appendix	27
28	Bibliography	28
29	Index	29
30	Summary	30
31	Abstract	31
32	Introduction	32
33	Methodology	33
34	Results and Discussion	34
35	Conclusion	35
36	References	36
37	Appendix	37
38	Bibliography	38
39	Index	39
40	Summary	40
41	Abstract	41
42	Introduction	42
43	Methodology	43
44	Results and Discussion	44
45	Conclusion	45
46	References	46
47	Appendix	47
48	Bibliography	48
49	Index	49
50	Summary	50
51	Abstract	51
52	Introduction	52
53	Methodology	53
54	Results and Discussion	54
55	Conclusion	55
56	References	56
57	Appendix	57
58	Bibliography	58
59	Index	59
60	Summary	60
61	Abstract	61
62	Introduction	62
63	Methodology	63
64	Results and Discussion	64
65	Conclusion	65
66	References	66
67	Appendix	67
68	Bibliography	68
69	Index	69
70	Summary	70
71	Abstract	71
72	Introduction	72
73	Methodology	73
74	Results and Discussion	74
75	Conclusion	75
76	References	76
77	Appendix	77
78	Bibliography	78
79	Index	79
80	Summary	80
81	Abstract	81
82	Introduction	82
83	Methodology	83
84	Results and Discussion	84
85	Conclusion	85
86	References	86
87	Appendix	87
88	Bibliography	88
89	Index	89
90	Summary	90
91	Abstract	91
92	Introduction	92
93	Methodology	93
94	Results and Discussion	94
95	Conclusion	95
96	References	96
97	Appendix	97
98	Bibliography	98
99	Index	99
100	Summary	100



# NIM Model 623B

## 8-Channel Updating Discriminator

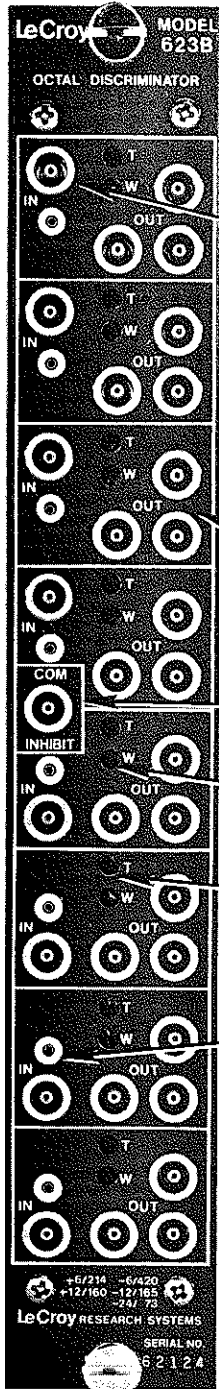

50  $\Omega$  Input, <4% reflections

3 NIM level outputs; quiescently, 0 V; -800 mV during output

Common Inhibit. -600 mV disables all channels.

Continuous width adjust,  $\leq 6$  nsec to  $>150$  nsec

Threshold Adjust, -30 mV to -1 volt; stability  $<0.2\%/^{\circ}\text{C}$

Threshold monitor point; reads 10X actual threshold

STD AEC/NIM packaging, in conformance with AEC report TID-20898; #1 width module

THE UNIVERSITY OF CHICAGO  
DEPARTMENT OF CHEMISTRY  
5301 SOUTH CAMPUS DRIVE  
CHICAGO, ILLINOIS 60637

RESEARCH ASSISTANT

APPLY TO: DR. J. H. WILSON  
DEPARTMENT OF CHEMISTRY

UNIVERSITY OF CHICAGO

5301 SOUTH CAMPUS DRIVE

CHICAGO, ILLINOIS 60637

TELEPHONE (312) 527-5000

FOR MORE INFORMATION CONTACT:

DR. J. H. WILSON

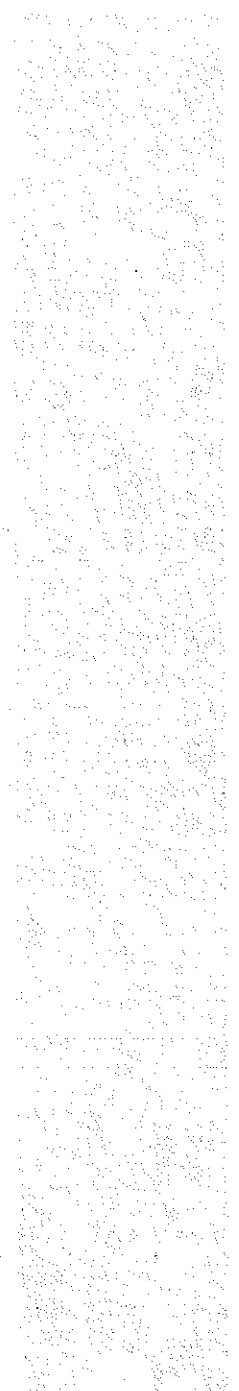

## SECTION 1

### SPECIFICATIONS

#### 1.3 Input Threshold Characteristics

##### 1.3.1 Threshold Range

The threshold range of 623 Series Octal Discriminators is -30 mV to -1 volt. Because the front panel screwdriver-adjustable potentiometer becomes increasingly sensitive as the threshold is increased, it eventually reaches a point (approximately -600 mV) beyond which it becomes difficult to set. Thus beyond the -600 mV level it should be assumed that the discriminator will attain its maximum threshold setting of -1 volt with negligible additional turning of the pot.

The low minimum threshold of the 623 series units makes it possible to use lower gain photomultipliers, lower voltage on phototubes and to drive PM signals over longer cable lengths than would be possible with higher thresholds. Compared with a -50 mV discriminator, for instance, utilizing RG-58 cable, the -30 mV discriminator would permit cable runs 66.7 feet longer than those permitted by a -50 mV discriminator for equal amplitude pulses. In addition, the low minimum threshold helps make it possible for one to back-terminate at the photomultiplier to absorb reflections and high amplitude noise. (In this case, the PM drives 25 ohms, the tube current is shared, and the amplitude is half that of the unterminated system.)

##### 1.3.2 Threshold Uncertainty

Often the threshold of a discriminator is assumed to be strictly that value which is written on a spec sheet or determined by a front panel potentiometer. The actual value can be a strong function of environmental conditions. The external factors with the strongest effect upon the threshold value are the temperature and the power supply voltage. The 623 Series has excellent threshold stability (see Figure 1.1) including less than 0.2%/°C change due to temperature variations.

##### 1.3.3 Threshold Memory

In order for a user to be assured of a well defined threshold value, this value must remain constant for typical conditions encountered. If a discriminator's threshold is affected by previous events, it is said to have threshold memory. To the user, this is an additional threshold uncertainty, since the discriminator's threshold for any given event depends upon the elapsed time from the preceding threshold crossing. In most discriminators, threshold memory (or second pulse sensitivity) becomes much larger as the pulse separation is reduced. The effect can be further aggravated by the amplitude of the initial signal. In some circuits a very large input can effectively paralyze the discriminator for a long period following the overload.

Figure 1.2. shows the threshold memory of the 623 series discriminators for a signal 20 dB over threshold and when the first input is just slightly above threshold.

Note that in both cases the threshold memory effect for the second pulse is within 6% of nominal for all spacing wider than 9 nsec. The second graph (i.e., the one more favorable to the discriminator) shows exceptionally clear response with virtually no effect in evidence above 10.5 nsec.

#### 1.3.4 Threshold Calibration

Determination of the input threshold set by the front panel control has typically required the experimenter to calibrate each change in setting with an external pulse source and oscilloscope. Newer discriminators offer a front panel test point whose DC level is proportional to the actual discriminator threshold. Not only does this allow rapid and simple determination of threshold, but it also allows the experimenter to easily return the threshold level to a previously recorded setting. The convenience, and therefore the usefulness, of this feature is strongly dependent upon the characteristics of this monitor voltage, particularly its linear proportionality with the threshold setting. Figure 1.3 indicates the characteristic curve of monitor voltage vs. threshold for the LeCroy 623 Series Discriminators.

#### 1.3.5 623 Series Threshold Hysteresis

In standard 623 series discriminators, hysteresis is built into the front end, such that every threshold crossing will not trigger the discriminator unless the previous signal has returned to below approximately -15 mV. This avoids multiple pulsing due to, for example, fine structure riding on a flat-topped pulse. Note the examples in Figure 1.4.

In Example A, the pulse shape variations of the input pulse will not retrigger the discriminator even though they cross the threshold level at a time exceeding the double pulse resolution of the unit. In Example B, since the input signal does go back through -15 mV and then once again rises to exceed the -30 mV threshold level, two discriminator outputs would result.

### 1.4 Input Reflections

Input reflections probably account for the majority of multiple-pulsing problems encountered by users. As discriminator thresholds have become lower, the amount of reflected signal required to retrigger the unit has decreased accordingly. Unless the percentage of input reflections is reduced along with the minimum threshold value, the user finds himself in the situation where multiple-pulsing negates the usefulness of a lower threshold. The input reflections of a discriminator effectively determine the allowable dynamic range of event or noise input signals.

A limited dynamic range may mean that minimum threshold values will have to be set higher to prevent multiple pulsing on noise or large (shower) event signals. In addition, high input reflections also limit the ability of a discriminator to be used to restandardize logic signals which have been degraded by long cables.

Figure 1.5 shows the maximum input voltage and allowable dynamic range as a function of discriminator input reflections.

As is evident, the 623 series discriminators offer a dramatic improvement in input reflection suppression over previously available discriminators. Because of the extremely low reflection coefficient of the 623's (i.e.,  $<2\%$  for inputs of risetime  $\geq 2$  nsec), maximum input signal is more than a volt larger than it would be for a unit exhibiting the typical 10% reflections, offering five times increase in the discriminators' dynamic range.

#### 1.5 Common Inhibit

All eight channels of the Model 623B may be disabled by a common front panel NIM input. A time difference of 6 nsec exists between the analog and the inhibit inputs. In order to inhibit, the leading edge of the veto should precede the threshold crossing by 6  $\pm$  1 nsec. The actual time inhibited is 5 nsec shorter than the duration of the veto input.

#### 1.6 Bridged High Impedance Input Factory Option

Certain 623 series modules are offered with bridged high impedance input options. The bridged high impedance inputs permit a user to drive only one cable from the photomultiplier to the discriminator to permit subsequent fast logic decision and pattern recognition to be performed. A popular method in the absence of this discriminator input option is to run two cables, one of which is from the dynode, which then must be inverted before the ADC or discriminator could accept it.

For this bridged input option, the left lower output connector is generally sacrificed to provide the additional input. A silver-colored ring is placed around this connector (as well as around the original input connector) when the unit is modified for this option to signify the fact that there are now two input connectors. In standard usage, the silver-colored ring usually specifies complementary output.

#### 1.7 Output Characteristics

**Low Impedance Voltage Output:** The Model 623 series discriminators require only one output driver (for 3 outputs) per channel. This driver requires no quiescent current, thereby permitting extremely small average power dissipation while still providing fast output response time. The output amplitude, although somewhat dependent on the number of output loads, will always be more negative than -800 mV in the logic "1" state.

The low impedance voltage output stage response times will be optimum when driving at least two 50 ohm loads.

### 1.7.1 Output Width

The output pulse width range for the 623 is 6 to 150 nsec. For the 623A the range is 7 to 50 nsec. Both ranges are continuously adjustable via front panel width potentiometers. The control allows coarse adjustment near maximum width and precise adjustment for narrower settings.

### 1.7.2 Output Width Uncertainty

The output width of most discriminators is a nominal value determined by the front panel potentiometer. Dispersion caused by variation in the discriminator input amplitude (jitter) results in a broadening of the skirts on the timing curve. In the LeCroy 623 series discriminators, this contribution is virtually non-existent as indicated in Figure 1.6.

The other main contributions to output width uncertainty are a function of external conditions in a manner similar to threshold uncertainty. Variations in both temperature and voltage can cause significant changes in output width with undesirable consequences identical to dispersion caused by input amplitude.

Figure 1.7 indicates the uncertainty in output width of the 623 series discriminators as a function of reasonable variations in temperature and supply voltage.

### 1.7.3 Updating

The LeCroy 623 series discriminators are all updating. In an updating discriminator the output is extended if a second pulse comes in before the first output returns to zero, as long as the second pulse arrives at a time later than the double-pulse resolution of the unit. Thus, the second pulse will be seen by the front end even though an output pulse is still present from the first signal, and that second pulse will cause a new output to be generated and added (in time) to the portion of the original output that already occurred.

## 1.8 Timing Characteristics

### 1.8.1 Double-Pulse Resolution

The speed of a discriminator is practically defined by its double-pulse resolution, or the time between the leading edges of the most closely spaced pulse pair for which the discriminator produces two distinct output pulses. Although simple in concept, this specification can be misleading unless the input conditions are precisely defined and performance fully specified. Characteristic curves which describe double-pulse resolution for the 623 series are in Figures 1.8 - 1.10.

**Double-Pulse Resolution vs Input Amplitude:** The double-pulse resolution of some discriminators is a strong function of the amount overdrive. Typical anomalies include substantial increases in

amplitude to achieve minimum pulse pair resolution (which is an effective threshold increase as a function of rate) and/or limited input dynamic range over which the discriminator adheres to specifications. A third effect is equivalent to tracking error. Does a discriminator have 8 nsec DPR if it never produces output pulses spaced more closely than 10 nsec apart? In some cases this effective timing error can be much larger than time shift due to intrinsic slewing or risetime dependent slewing. Figure 1.8 shows the minimum double-pulse resolution of the LeCroy 623 series discriminators as a function of input amplitude from threshold to 10X threshold.

It is worth noting that the 623's maintain a DPR of under 9 nsec for all inputs over the 10:1 dynamic range. Although not featured as part of the general specifications, the double-pulse resolution is much better than specified over most of the measured dynamic range. Also significant is the absence of tracking error at the limit of the discriminator's input performance. Throughout the measured range, the time shift of the output averages 2.54% or approximately 200 psec.

**Double-Pulse Resolution vs Input Width:** The DPR of a discriminator is a strong function of the duration of the first pulse in an input pair, since this width affects the recovery time allowed the discriminator input stage between the two pulses. If the double-pulse resolution is not linear with input width, it may mean that the discriminator will not respond to the second pulse following an overload photomultiplier signal. The double-pulse resolution vs input width of the 623 series discriminators is shown in Figure 1.9. This figure demonstrates that the discriminator's response is linear with input width and has a fixed recovery time of 4 nsec following an input of any duration.

### 1.8.2 Tracking Error

The ability of a discriminator to be used for precise timing (coincidence or TOF) in an environment which encounters narrow pulse pair separations is demonstrated by considering the time shift (or tracking error) introduced as the time interval between successive inputs is reduced. In an experiment, tracking error is equivalent to time dispersion as a function of input rate. For many experiments, this can be critical, since it is often in high rate situations that the best timing resolution is required.

Tracking error of the 623 series discriminators as a function of input pulse spacing is indicated in Figure 1.10.

### 1.8.3 Slewing

For input rates which do not tax the double-pulse resolution of the discriminator the most important characteristic which defines the fidelity of the discriminator output to the time information in the input signal is slewing. This is defined as variation in the input-to-output time delay of a discriminator with input amplitude.

The net measured slewing yielded by a discriminator has two components, one contributed by the discriminator itself (intrinsic slewing) and the other dependent upon the input risetime.

Intrinsic slewing might be defined as the slewing measured with a delta function input. Risetime dependent slewing arises from the fact that the discriminator fires earlier on the leading edge of a large pulse of finite risetime than on one of smaller amplitude with the same risetime. For an extreme range of pulse heights, the maximum contribution is equal to the 0 to 100% risetime of the pulse.

With most discriminators, the largest portion of the slewing occurs in the amplitude region just above threshold. Threshold being defined as the input amplitude that produces 50% triggering. Slewing specifications are frequently given over an input amplitude range from threshold to a specified overload factor (such as 10X threshold).

No commonly accepted standard exists for measuring the slewing characteristics of discriminators. One technique which LeCroy considers relevant to describing a discriminator's timing characteristics is to obtain a time spectrum of shift in input-output delay when a uniform spectrum of pulse heights from below threshold to many times threshold is used to drive the discriminator. Such an input spectrum constitutes a relatively severe test of the discriminator's timing performance for it contains a relatively higher proportion of near threshold pulses than does a usual beam-derived photomultiplier spectrum. It takes into account all aspects of discriminator slewing performance and presents their combined effect in terms of a time dispersion curve such as indicated in Figure 1.11.

### 1.9 Packaging

The NIM 623 series discriminators are all packaged in a #1 NIM module with LEMO-type connectors. Due to front panel space limitations, the 623's are not offered with BNC connectors. The CAMAC 2623 is packaged in a #2 CAMAC module with LEMO-type connectors.

### 1.10 Current Requirements

In order to provide an octal discriminator with fast response times and output levels greater than 800 mV, a large amount of supply current is required. The models 623 and 623A require about 11 watts. Therefore, if more than 9 of these units are to be used in a bin, the bin power supply must be capable of providing more than the standard 96 watts. A 200 watt NIM bin (Model 1002) is available from LeCroy.

### 1.11 Recommended Use of the NIM Power Bins

It is highly recommended any NIM bin be kept at as constant a temperature as possible, using air conditioning and fans to assure air flow through all modules in every bin. Elimination of large temperature variations removes the possibility of temperature drift effects upon modules and the forced air flow is good insurance against the potential failure of



components in the modules due to excessive heating for extended periods of time. Despite the fact that all components are pre-aged and burned-in before insertion into LeCroy modules, and the modules themselves are temperature cycled for days under power between initial test and final test, it is recommended that subjecting any modules to adverse operating conditions be avoided when possible.

#### 1.12 Input Protection

The inputs of 623 series discriminators are protected to 5 A for 0.5  $\mu$ sec, clamping at +1 and -7 volts. Beyond these voltages the input is no longer terminated in 50  $\Omega$  and substantial reflections will occur.

The DC protection is limited by the 0.25 watt dissipation limit on the input resistor, which can be assumed to offer protection against DC signals between -5 volts and +5 volts.

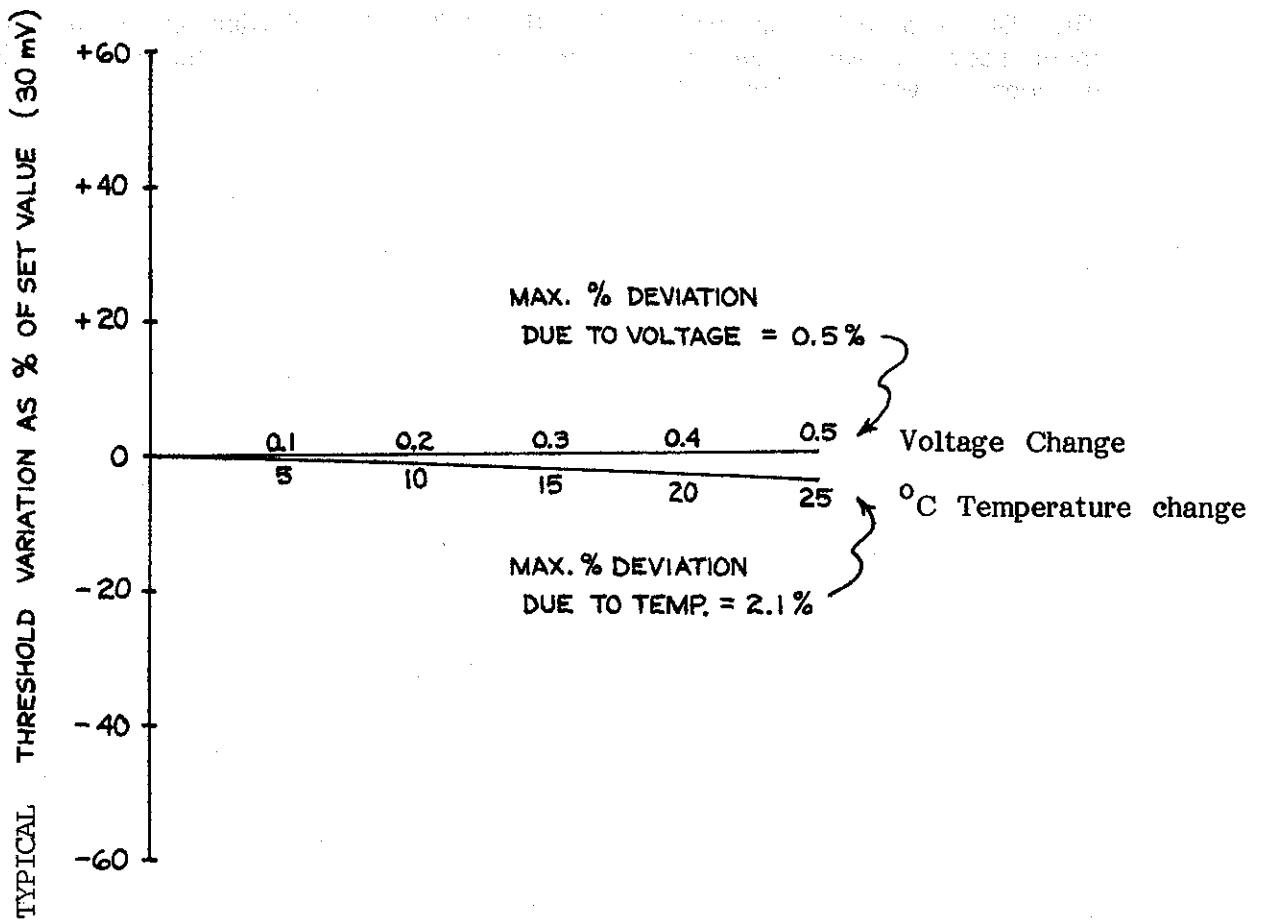
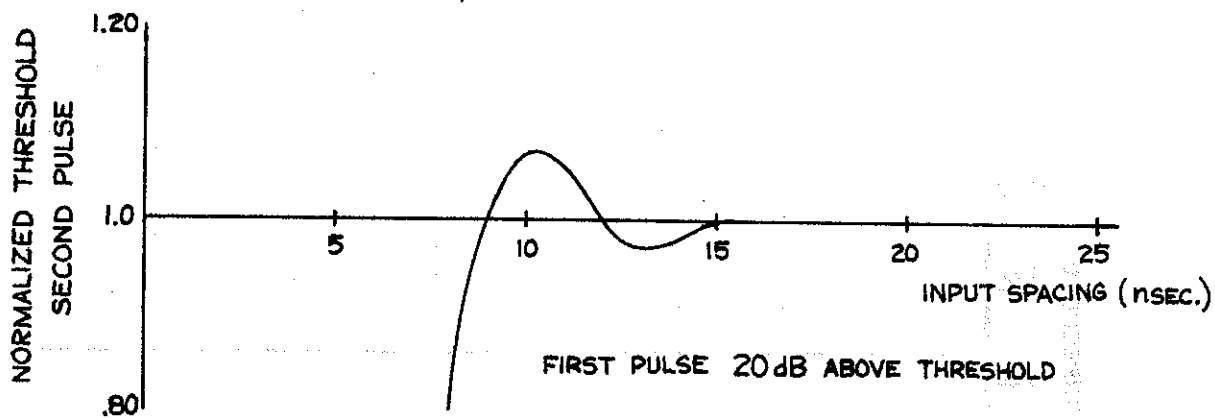

Figure 1.1

623 SERIES THRESHOLD MEMORY



623 SERIES THRESHOLD MEMORY

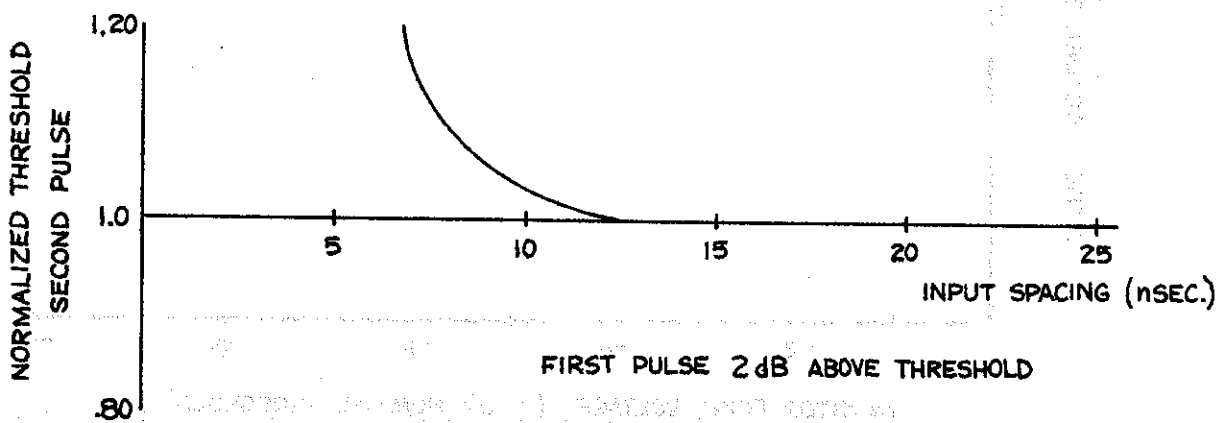

Figure 1.2

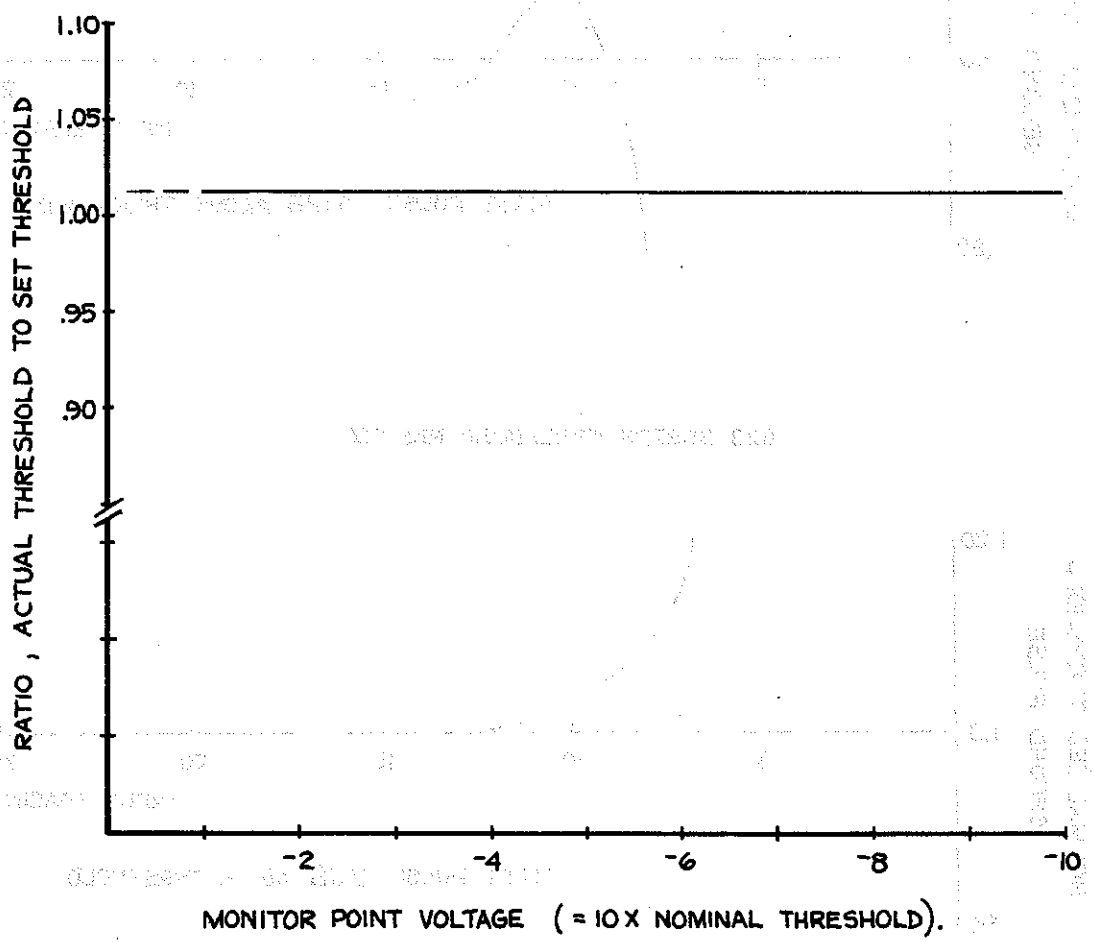

Figure 1.3

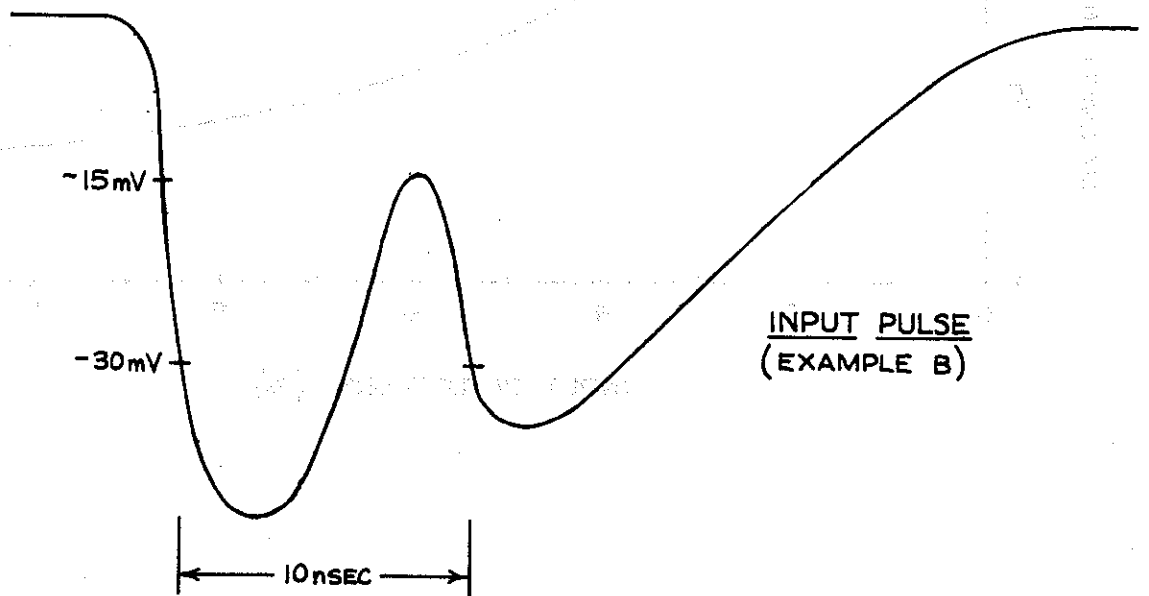
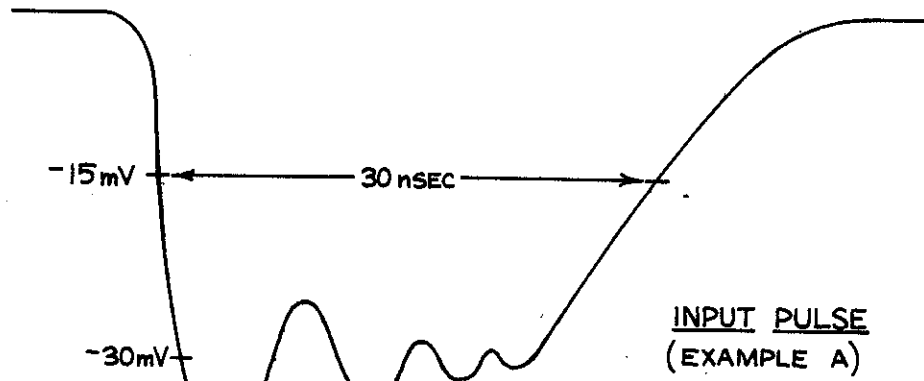

Figure 1.4

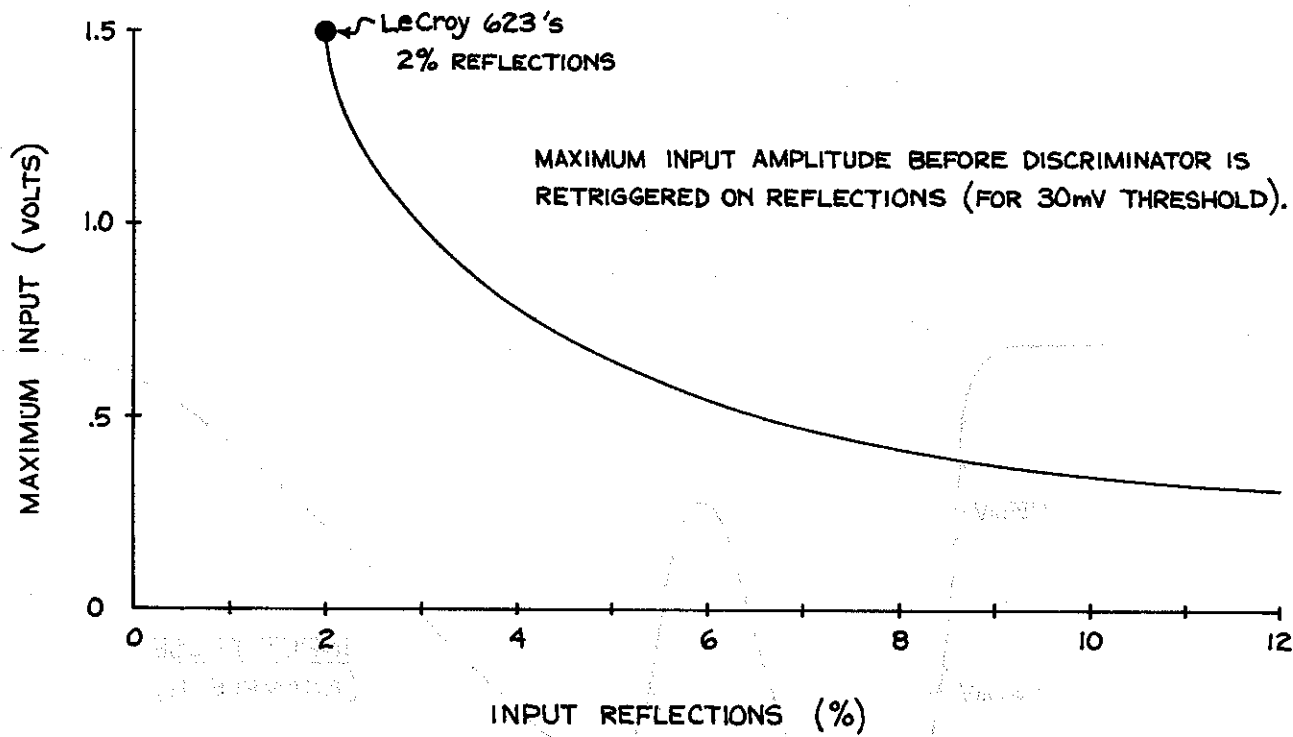

Figure 1.5

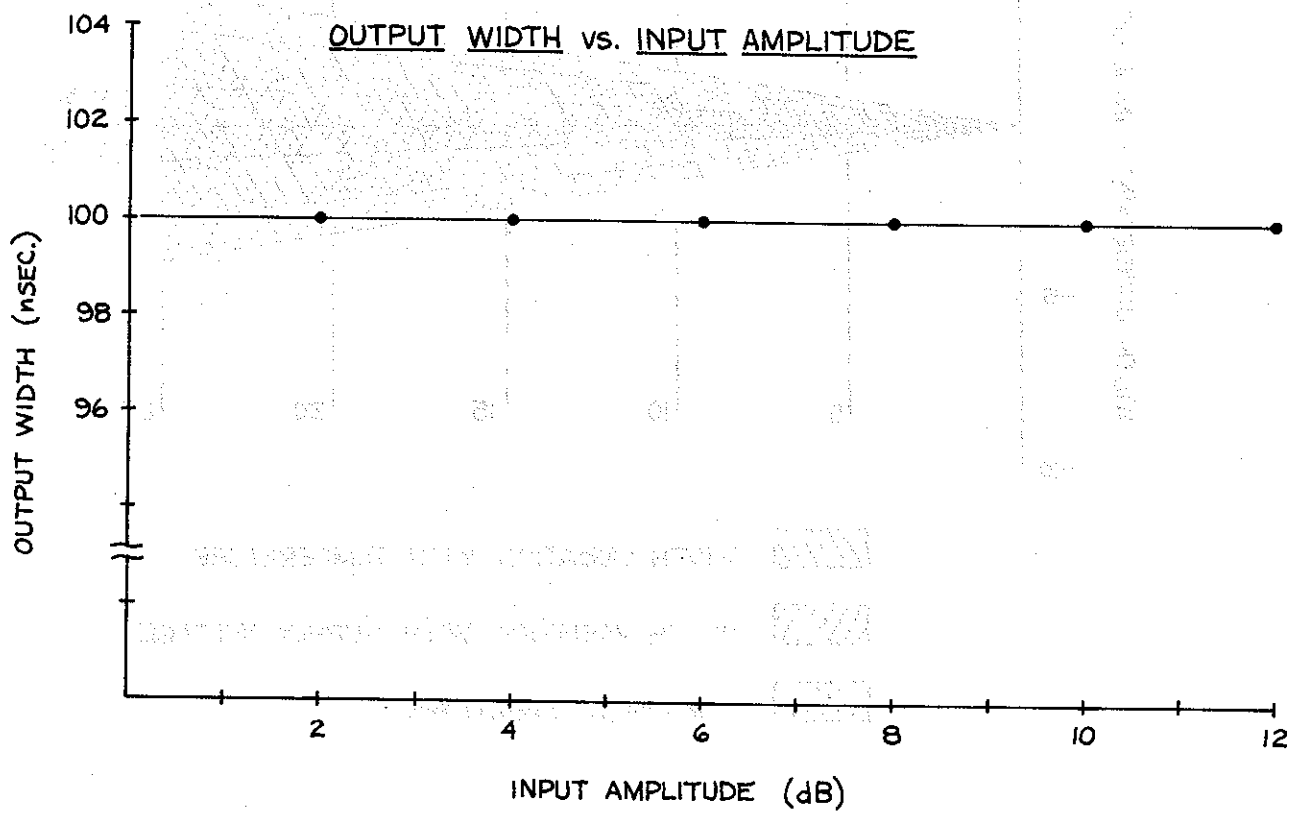

Figure 1.6

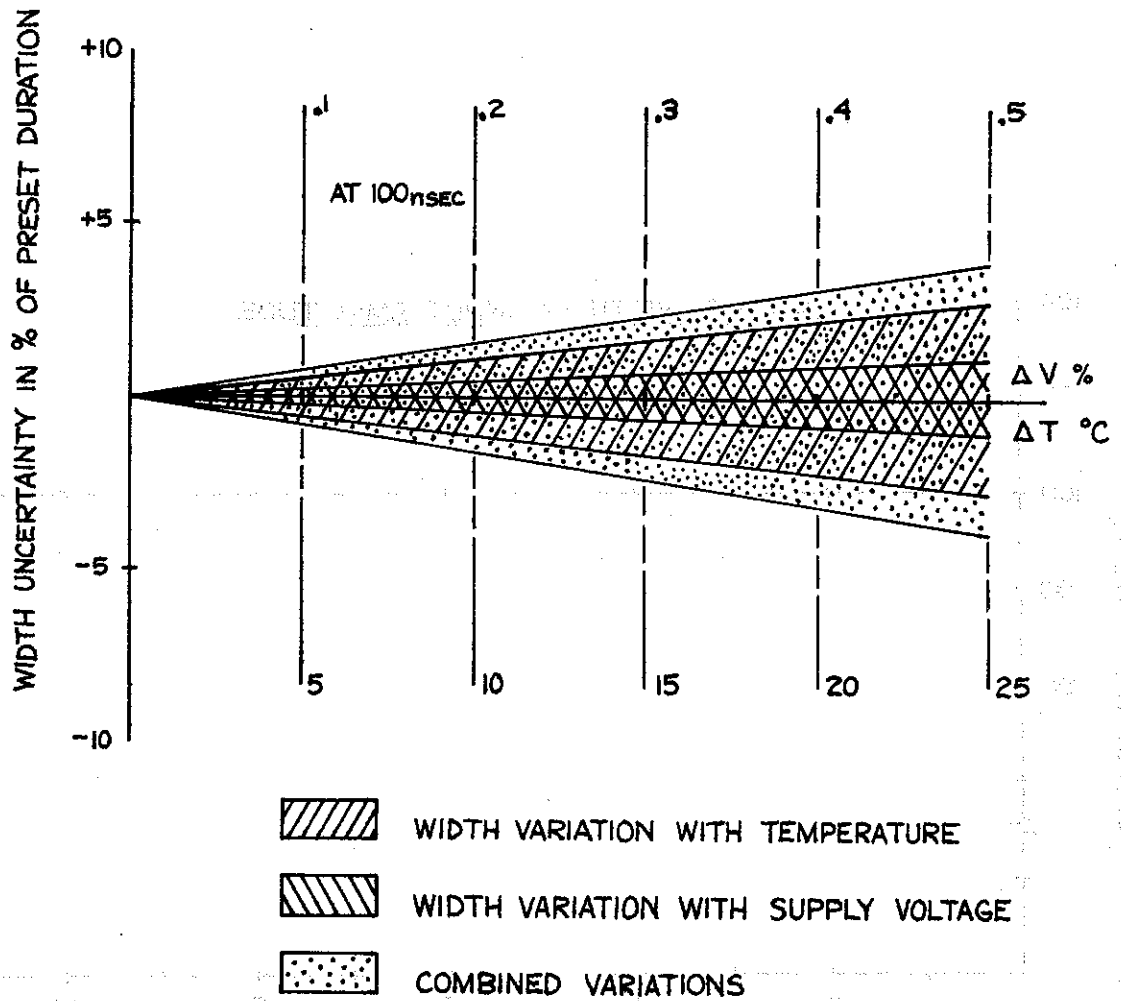

Figure 1.7



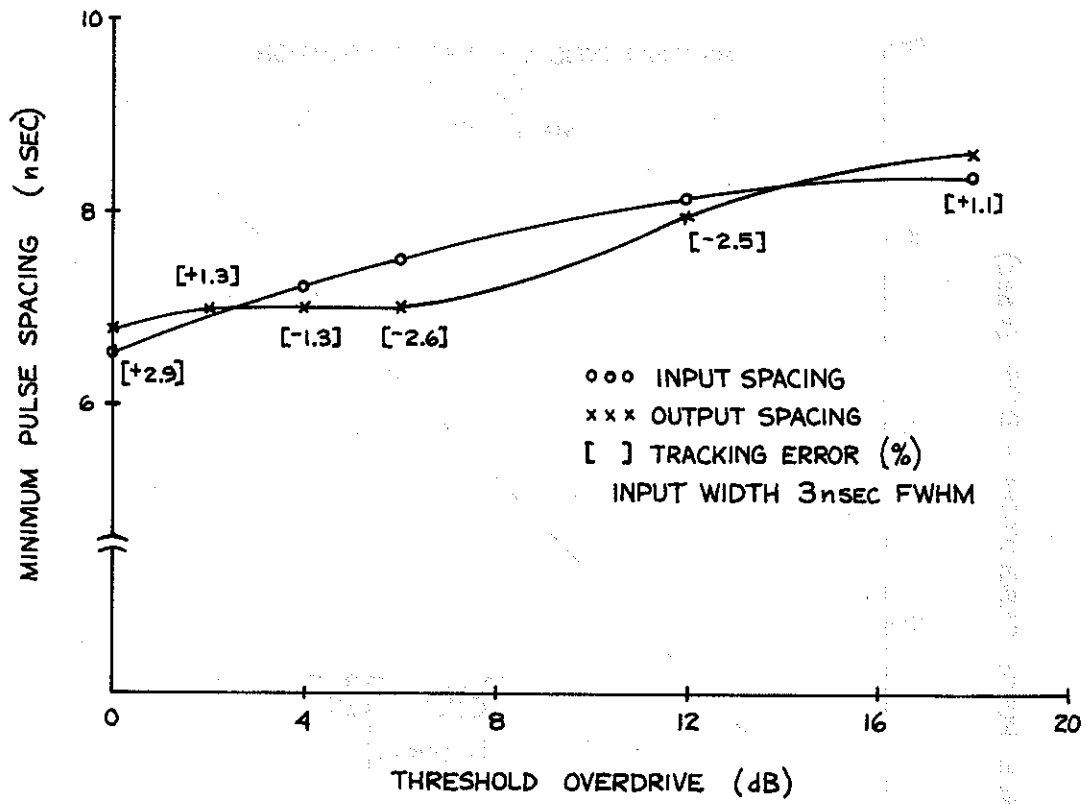

Figure 1.8

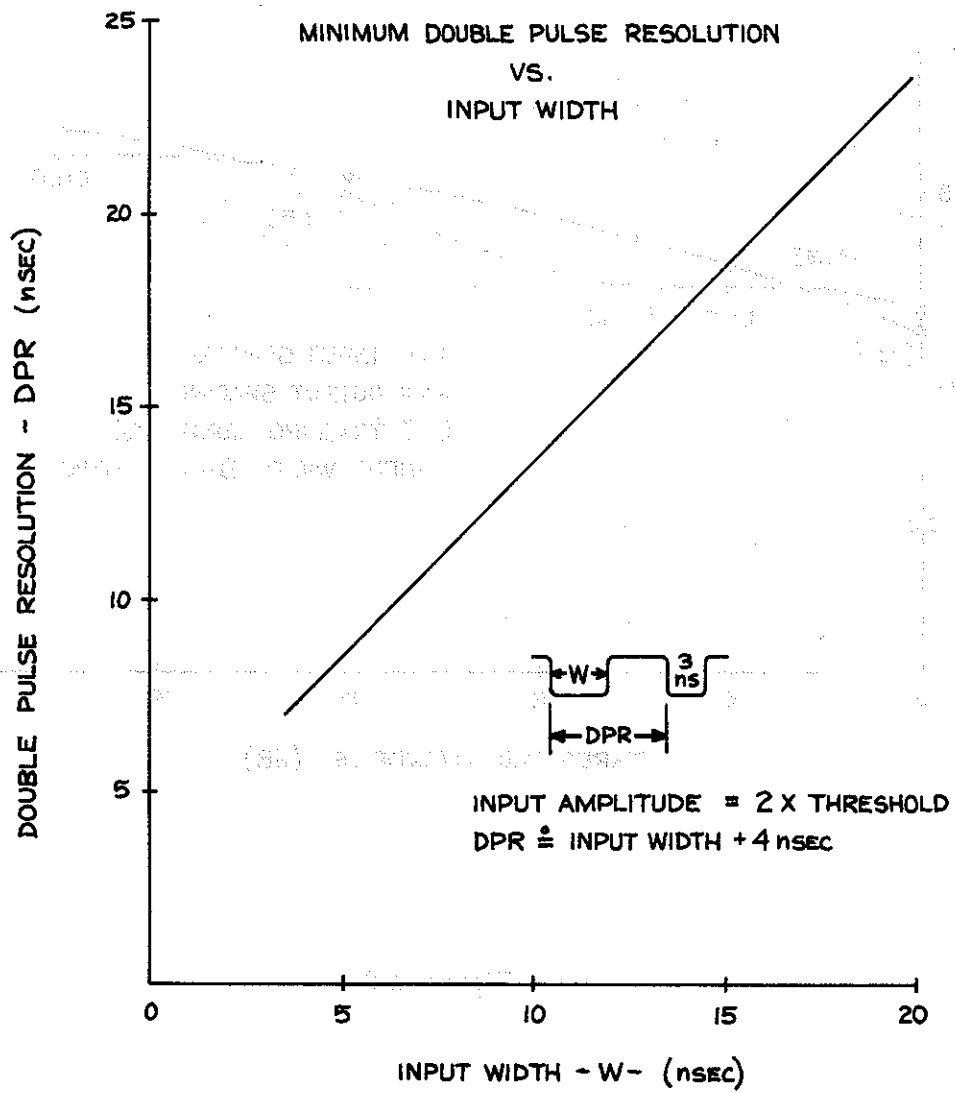

Figure 1.9

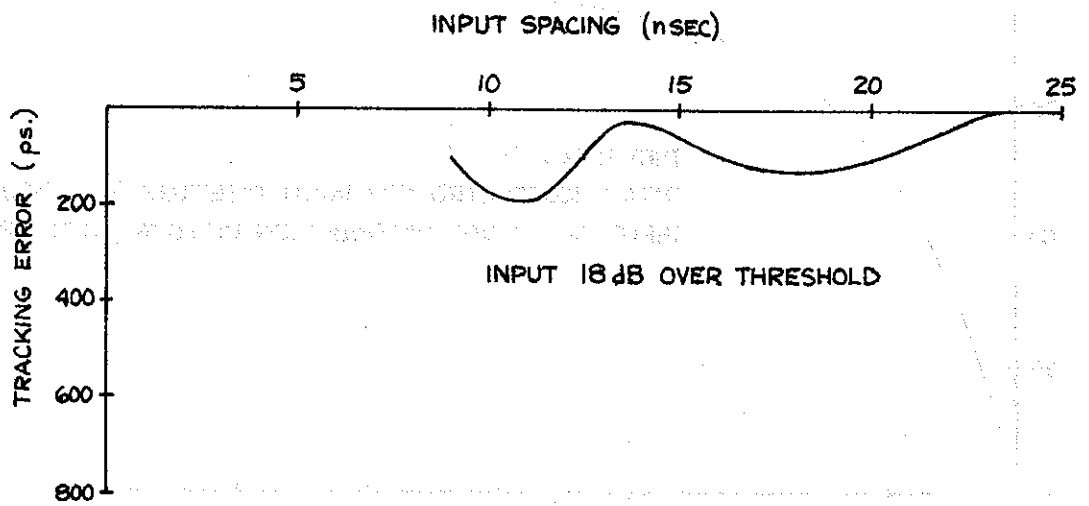
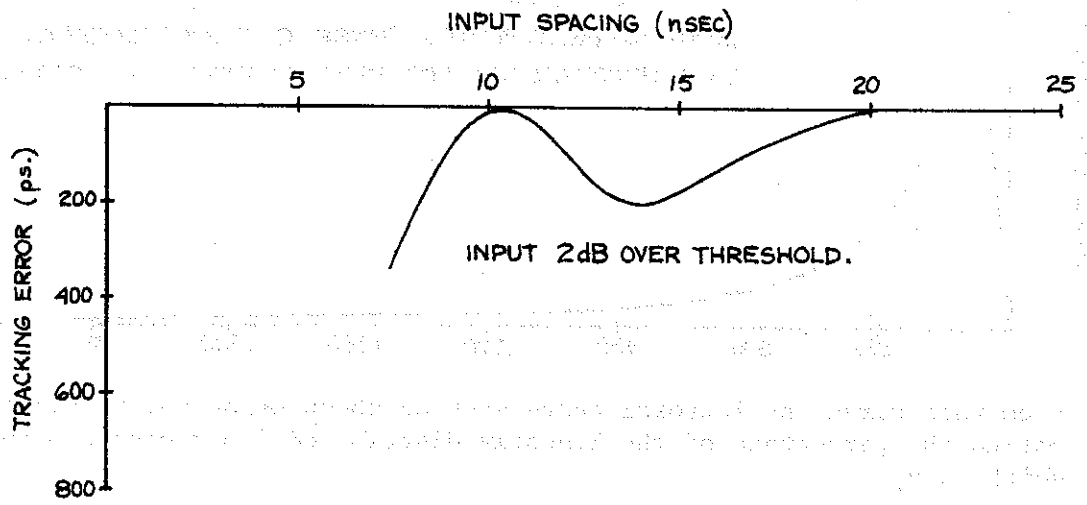
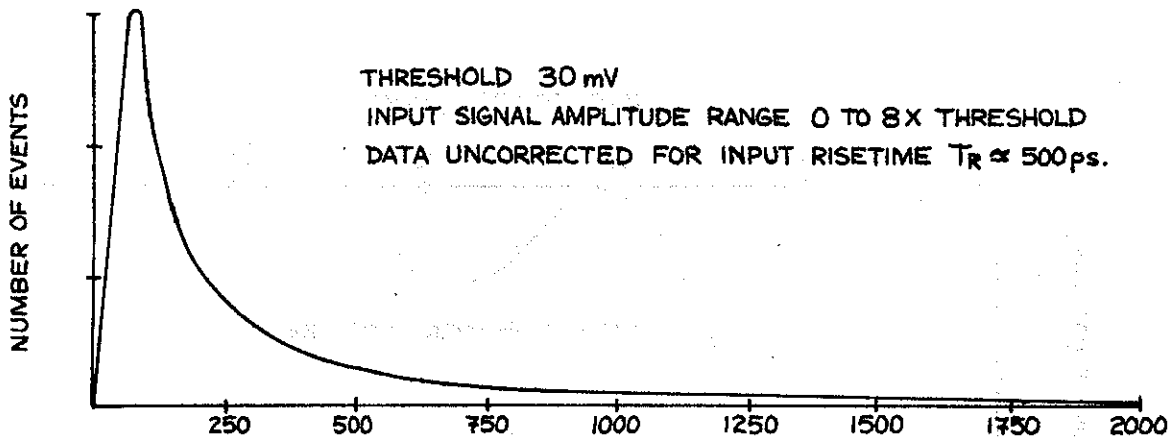

Figure 1.10



From this curve, an integral curve such as shown below may be plotted indicating the percentage of the linearly distributed input events with time shift  $\leq t$ .

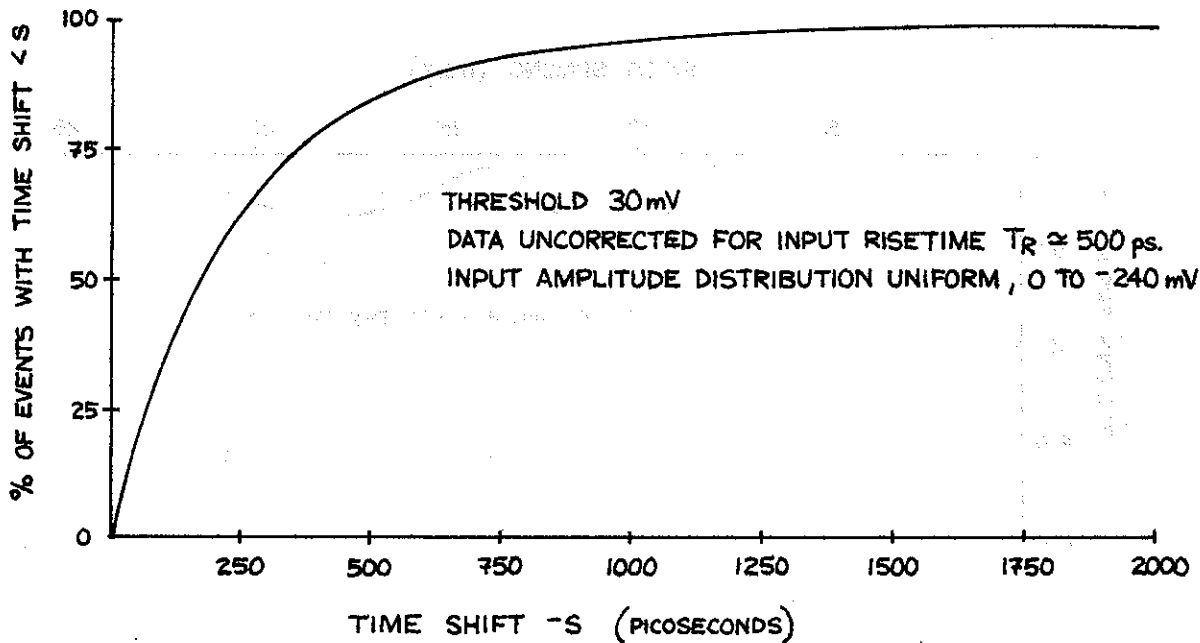

Figure 1.11

## SECTION 2

### TECHNICAL DESCRIPTION

#### 2.1 General

Each of the four channels of the 623 series models is composed of three basic sections:

1. Input and discriminator stage
2. Timing or pulse-former stage
3. Output stage.

A block diagram of the 623 series models can be seen in Figure 2.1, and a complete schematic of a specific model can be found in the rear pocket of this manual.

#### 2.2 Input and Discriminator

The input and discriminator stage is based on the LeCroy Model LD601 hybrid. This unit contains all of the circuitry of the discriminator with the exception of the input termination and high voltage protection. The LD601 is functionally presented in Figure 2.2. The threshold level is set by changing the voltage bias on a fast differential amplifier which has a small amount of positive feedback to provide regeneration at threshold. In actual operation the  $V_T$  input is grounded, and the threshold level is determined by the 10:1 voltage divider (composed of the external 999  $\Omega$  and internal 100  $\Omega$  resistors) operating from a voltage which is set by a front panel potentiometer and monitored at the front panel test point.

The measured voltage will be 10 times the actual threshold voltage. When an input signal applied to -IN is equal to the threshold voltage at +IN, the amplifier output will begin to go positive. This will force +IN closer to 0 volts, which increases the differential input voltage in such a direction that the output locks and then the cycle reverses. The amplifier output thus provides a time-over-threshold pulse with fixed amplitude. This pulse can be monitored at the AMPL. OUT point (pin 6). The quiescent level should be nominally -2.4 volts going to -1.6 volts during the pulse. The leading edge of this output sets the latch circuit which is used as a pulse width standardizer. Before the amplifier and the latch can be set, the inhibit inputs (used for the bin gate) must be off. The required level at Pins 7 and 16 of the LD601 must be 0 to -1.6 V to enable, and -2.5 to -6.0 V to disable. The purpose of the first inhibit is to avoid generating a low level transient at the output associated with the leading edge of an amplified input pulse inhibited at the dV/dt stage only. (The common bin gate driver shifts this so that 0 volts at the Bin Gate input will inhibit, greater than +3 volts will enable). Once the latch is set, a latch OUTPUT is available to start the 623 series timing stage. The OUTPUT amplitude and leading edge should be similar in appearance to the AMPL OUT above, but the width of the output will be fixed

independent of the input width. Internally, the latch output is fed back to reset the latch after a short time delay, thus generating a short output pulse whose actual width can be set by the proper external selection of RC time constant and voltage levels at Pins 3 and/or 4. It is set at approximately 3 nsec in the 623 series models.

Two trim resistors, T1 and T2, are associated with this stage (see enclosed schematic). T1 sets the minimum threshold. T2 calibrates the LD601 threshold to the test point voltage at its respective channel. If the LD601 is changed, T2 will probably require trimming.

### 2.3 Timing Stage

The output of the LD601 drives a fast NPN switching transistor. Normally this transistor is found in its cut off region, its collector is clamped to approximately 400 mV by a Schotkey diode. This 400 mV level biases the PNP output stage driver transistor, Q2, to its cut off state. In this state the voltage across the 7.5 pF timing cap is approximately 3.2 volts. When the LD601 provides an input pulse to the timing stage the NPN device turns on (it is prevented from saturating by the anti-saturation diodes), the voltage at the collector is negative such that the PNP driver turns on and supplies a pulse to the output stage. The duration of this pulse is determined by the time constant consisting of the equivalent resistance of the front panel potentiometer and trim resistors and the 7.5 pF cap. Since the final voltage to which the cap can charge is much greater than the point where it is clamped, a fairly linear ramp is produced on the collector of the NPN. When the capacitor voltage crosses the base threshold voltage of the PNP, the drive turns off and allows the output stage to return to its quiescent level.

### 2.4 Output Stage

The output stage is a simple NPN inverter stage with the emitter returned to the negative 3.8 volt supply. The stage is normally biased in the cut off region. During an output pulse, sufficient base current is supplied from the LD601 to turn the output driver on. In the on condition, the collector voltage is approximately -2.7 volts. The 110  $\Omega$  series resistor and the 50 impedance of the load form a divider to provide a -840 mV output to the output connector. In order to reduce the turn off delay time of the output stage, the output driver is prevented from entering the saturation region by an anti-saturation technique, consisting of a conventional diode and a hot carrier diode.

### 2.5 Internal Power Supplies

Four internal power supplies are used to generate the -0.8, -3.8, +6 V and -6 V.

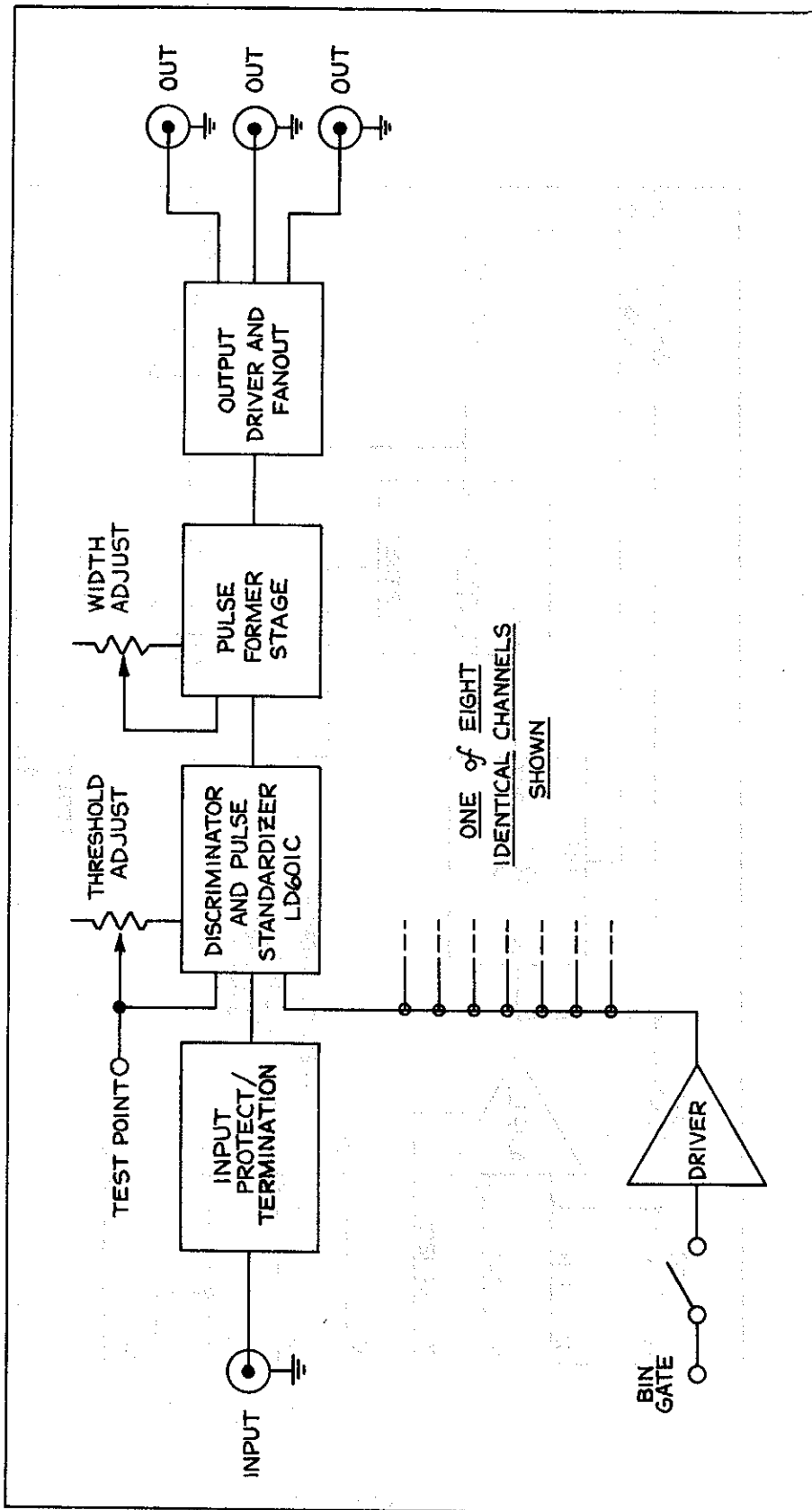

Figure 2.1

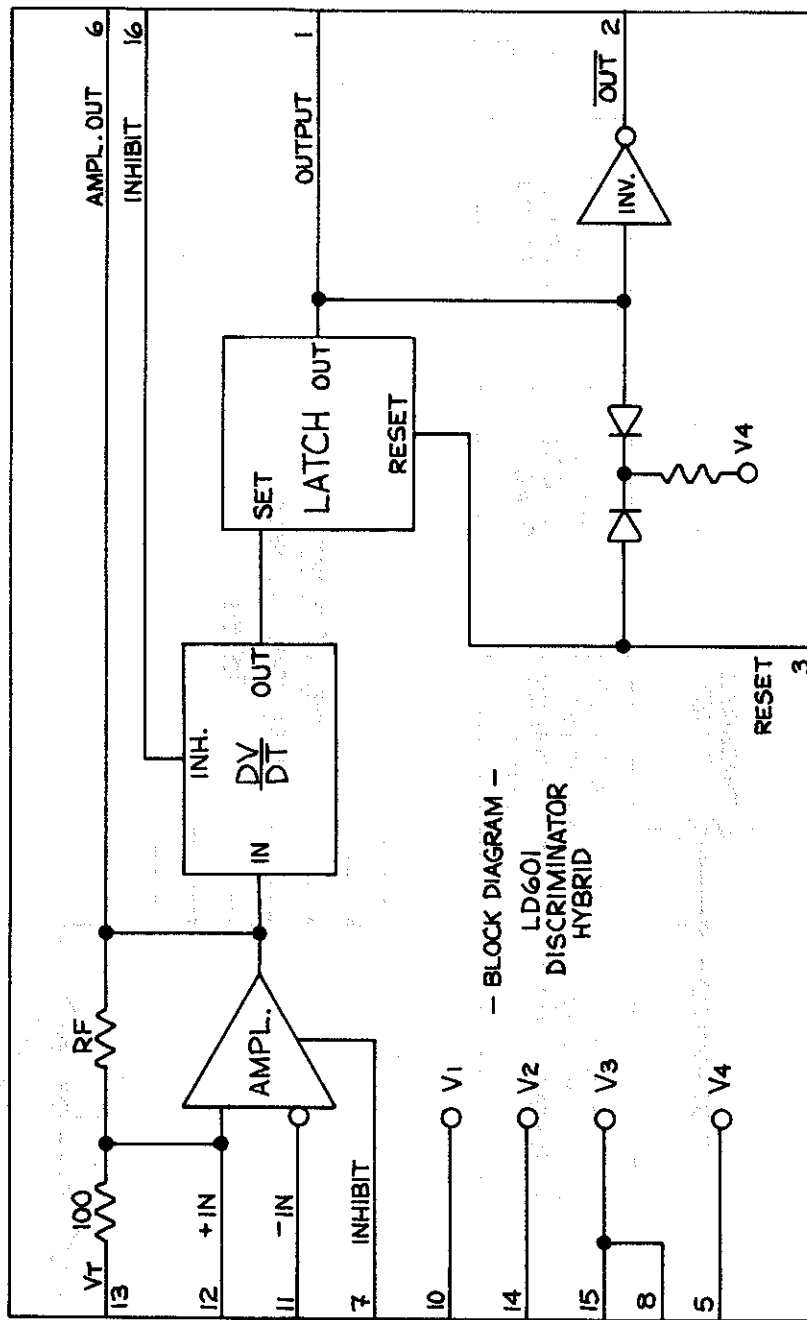

Figure 2.2



## SECTION 3

### TEST AND CALIBRATION

This Test and Calibration Section has been included to familiarize the service technician with the areas that should be checked when searching for sources of failures and after replacing components, especially front end hybrids (LD601's). The trouble-shooting section is by no means exhaustive, but it does provide insight into some of the problems that have occurred at LeCroy during the initial testing of the 623's. The technician should follow the "Trouble-Shooting Guide" for ease in determining the defective component. Replacement of critical components will require some recalibration.

#### 3.1 Trouble Shooting

##### Equipment Required:

1. Digital Voltmeter.
2. Sampling scope; 50  $\Omega$  input impedance.
3. High impedance real time scope with bandwidth of 150 MHz or greater (Tektronix 454, 475, or equivalent).
4. Pulse generator or signal source capable of producing 10 nsec - 50 mV pulse into 50  $\Omega$ .

##### Initial Set-Up:

1. Use NIM power extender cable to power the 623 under test.
2. Set all threshold and width pots to their full counter-clockwise position (threshold equal to -30 mV and width equal to less than 5 nsec).
3. Apply a 10 nsec negative pulse (approximately equal to -50 mV) in turn to each input. Check output on sampling scope.
4. Follow the "Trouble-Shooting Guide".

<u>Model</u>	<u>LD601C</u>	<u>LD601D</u>	<u>LD601E</u>
623	Direct Replacement	Cannot be used in 623	Cannot be used in 623
623A	Cannot be used in 623A	Direct Replacement	Direct Replacement

# TROUBLE-SHOOTING GUIDE

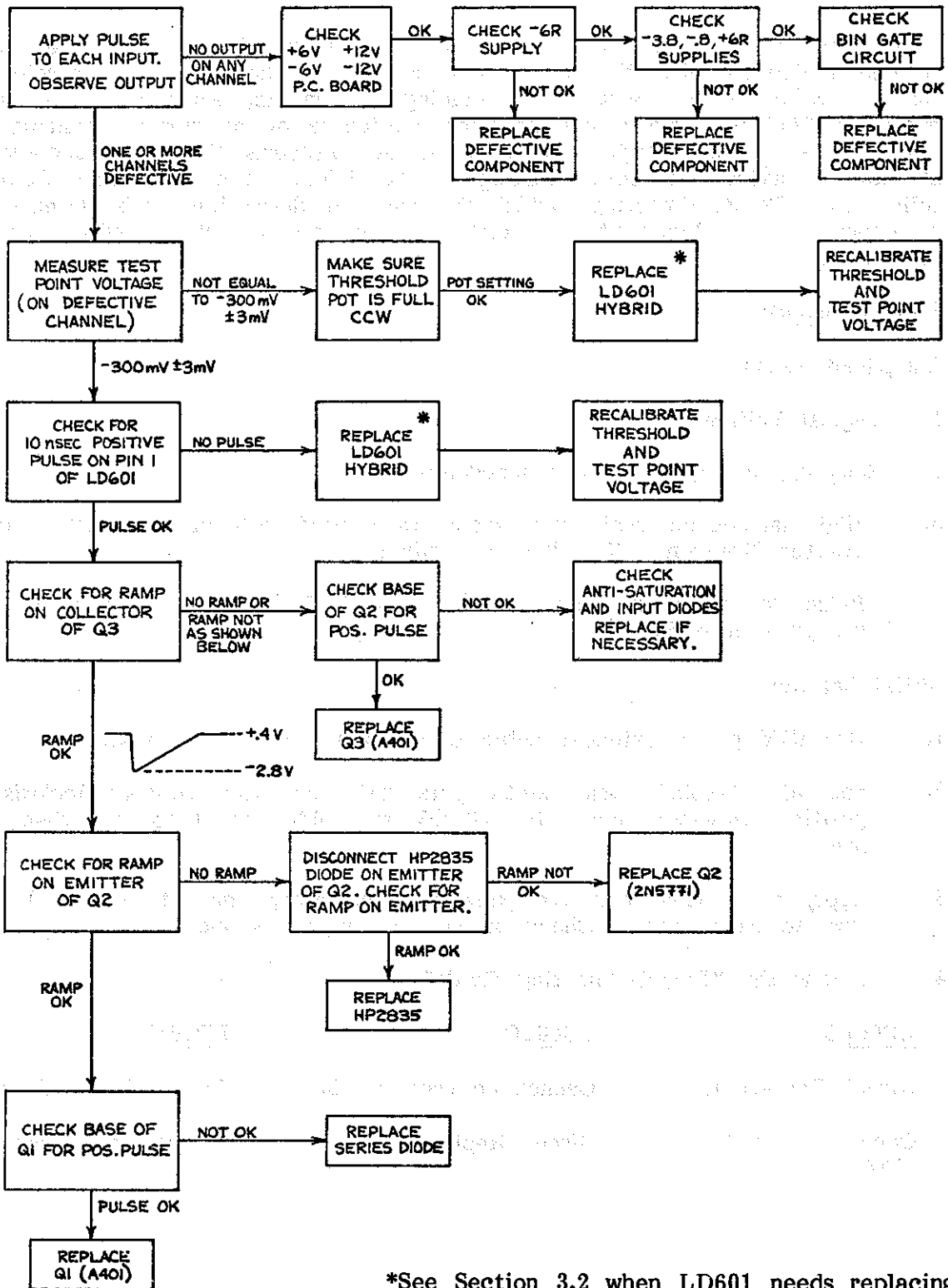

\*See Section 3.2 when LD601 needs replacing

### 3.2 Required Recalibration if LD601's are Replaced:

If any LD601 was found to be defective and required replacement, the Threshold and Test Point voltage should be recalibrated.

#### Procedure:

1. Set front panel Threshold pot to minimum (counterclockwise).
2. Measure Test Point voltage. If not equal to  $-300 \pm 5$  mV, replacing existing trim resistor  $T_1$  (across 5 K $\Omega$  pot) with proper resistance to bring Test Point voltage into required range (50 K to 150 K $\Omega$ ).
3. Check Threshold level with a 5 nsec wide pulse; if it is not -30 mV, replace existing trim resistor  $T_2$  (across 12.4 K $\Omega$  resistor) with proper resistance (50 K to 150 K $\Omega$ ).
4. Check minimum output width, set front panel width control pot fully counterclockwise, check pulse width - if it is not 6 nsec (or less) for model 623 or 7 nsec or less for model 623A, retrim by replacing trim resistor (across the 430  $\Omega$ ) with the proper value.
5. Check maximum output width, set front panel width control pot fully clockwise, check pulse width - if it is not 150 nsec (or greater) for model 623 or 50 nsec (or greater) for model 623A, retrim by replacing the trim resistors (across the width pot) with the proper value.

#### Replacement of Q3 and Q4:

Observe output width of less than 1  $\mu$ sec with front panel width pot set to its full clockwise position. Retrimming will be required. (See Calibration (9) Maximum Width).

#### Calibration

The following is a detailed step-by-step calibration procedure for the 623 Discriminator. The sequence should be followed to avoid extraneous labor.

#### Important

- a. When actual trim and calibration adjustments are performed, be sure the unit had at least 5 minutes of warm-up time. (Calibration may be off if warm-up time is too short).
- b. If for any reason, long periods of time between trimming occur, be sure to double check periodically the bin voltages (Step 3). (Power supply voltage may change and calibration may be off when performed to the new changed voltage).
- c. If at any check or calibration step problems occur, refer to the Trouble-Shooting Guide.

## Procedure

1. Check (on board) the presence and verify the following correct voltages: +6 V, +12 V, -24 V. These voltage points are clearly marked on the rear of the P. C. board.
2. -0.8 Volt Regulator - Measure the voltage on the -0.8 V bus. Readjust pot if voltage is not -0.8 V +8 mV.
3. -3.8 Volt Regulator - Measure the voltage on the -3.8 V bus. Readjust pot if voltage is not -3.8 V +38 mV.
4. +6 Volt Regulator - Measure the voltage on the +6 VR bus. Readjust pot if voltage is not +6 V +60 mV.
5. -6 Volt Regulator - Measure the voltage on the -6 VR bus. Readjust pot if voltage is not -6 V +60 mV.
6. Test Point - Set front panel threshold pot to minimum (counterclockwise). Measure test point voltage. If not equal to -300 +5 mV replace existing trim resistor T1 (across 5 K $\Omega$  pot) with proper resistance (50 K $\Omega$  to 150 K $\Omega$ ) to bring test point voltage into required range.
7. Threshold - With front panel threshold pot to minimum (counterclockwise), check threshold level with a 5 nsec wide pulse applied to input. If it is not -30 mV, replace existing trim resistor, T2, (across 12.4 K $\Omega$  resistor) with proper resistance (50 K $\Omega$  to 150 K $\Omega$ ).
8. Minimum Output Width - With front panel width control pot fully counterclockwise, check output width. If it is not between 5.75 and 6 nsec for 623 and 7 nsec for 623A, retrim by replacing the trim resistor (across the 430  $\Omega$ ) with the proper value.
9. Maximum Output Width - With front panel width control pot fully clockwise, check output width. If it is not between 150 and 160 nsec for the 623 and 50 nsec for the 623A, retrim by replacing the trim resistor (across the width pot) with the proper value.

Company Confidential Information: Unauthorized use or disclosure is prohibited

MODEL NO 6238  
 ECON 1001  
 PAN HIST. NO

OCTAL DISCRIMINATOR

PRINTED 20-May-8  
 REV DATE 19-May-8

9144

PAN HIST. DATE 24-May-79

QRS PART NO	DESCRIPTION	QT
102 245 103	CAP CERA DISC 25V .01 UF PT-FDCL-1/32 LEADS 3/8 AWG 22	5
102 444 220	CAP CERA DISC 100V 22 PF 10% S2L	
102 444 560	CAP CERA DISC 100V 56 PF 10% S3N	
102 944 *75	CAP CERA DISC 1KV 7.5 PF 10% S2L	
103 327 103	CAP CERA MONO 50V .01 UF 20% GENERAL PURPOSE	
105 217 102	CAP MUCON RIBB LD .001 UF HIGH-K CERA 25V 20%	
116 305 180	CAP DIP MICA BM 5 18 PF	
142 824 685	CAP TANT DIP CASE 6.8 UF 35V 20% .256 X .374	\$ 1
147 447 *50	CAP ALUM METAL CAN 50 UF 15 (16)V -10 +75% .328 X .578	\$
161 335 101	RES COMP 1/4W 5% 100 OHMS	
161 335 102	RES COMP 1/4W 5% 1 K	
161 335 103	RES COMP 1/4W 5% 10 K	2
161 335 104	RES COMP 1/4W 5% 100 K	
161 335 111	RES COMP 1/4W 5% 110 OHMS	
161 335 153	RES COMP 1/4W 5% 15 K	3
161 335 161	RES COMP 1/4W 5% 160 OHMS	
161 335 181	RES COMP 1/4W 5% 180 OHMS	
161 335 182	RES COMP 1/4W 5% 1.8 K	
161 335 200	RES COMP 1/4W 5% 20 OHMS	
161 335 202	RES COMP 1/4W 5% 2 K	
161 335 203	RES COMP 1/4W 5% 20 K	
161 335 241	RES COMP 1/4W 5% 240 OHMS	
161 335 242	RES COMP 1/4W 5% 2.4 K	
161 335 271	RES COMP 1/4W 5% 270 OHMS	
161 335 301	RES COMP 1/4W 5% 300 OHMS	
161 335 303	RES COMP 1/4W 5% 30 K	
161 335 362	RES COMP 1/4W 5% 3.6 K	
161 335 393	RES COMP 1/4W 5% 39 K	
161 335 431	RES COMP 1/4W 5% 430 OHMS	
161 335 473	RES COMP 1/4W 5% 47 K	
161 335 510	RES COMP 1/4W 5% 51 OHMS	
161 335 513	RES COMP 1/4W 5% 51 K	
161 335 560	RES COMP 1/4W 5% 56 OHMS	
161 335 561	RES COMP 1/4W 5% 560 OHMS	
161 335 563	RES COMP 1/4W 5% 56 K	
161 335 681	RES COMP 1/4W 5% 680 OHMS	
161 335 752	RES COMP 1/4W 5% 7.5 K	
161 335 823	RES COMP 1/4W 5% 82 K	
161 445 *56	RES COMP 1/2W 5% 5.6 OHMS	
161 665 241	RES COMP 2W 5% 240 OHMS	
161 665 390	RES COMP 2W 5% 39 OHMS	
168 531 269	RES PREC RN55D 51.1 OHMS	
168 531 326	RES PREC RN55D 200 OHMS	
168 531 389	RES PREC RN55D 909 OHMS	
168 531 485	RES PREC RN55D 9.09 K	
168 531 498	RES PREC RN55D 12.4 K	
181 457 103	RES VARI CERMET 10 K 1/2W 10%	
181 457 104	RES VARI CERMET 100 K 1/2W 10%	

Dear Mr. [Name],

I have received your letter of the 15th and am glad to hear from you.

The information you have provided is being reviewed.

I will contact you again once a decision has been reached.

Thank you for your patience.

Sincerely,  
[Signature]

[Address]

Company Confidential Information: Unauthorized use or disclosure is prohibited.

MODEL NO 623B

OCTAL DISCRIMINATOR

PRINTED 20-May-83

ECON 1001

REV DATE 19-May-83

FAN HIST. NO

9144

FAN HIST. DATE

24-May-79

LRS	PART NO	DESCRIPTION	QTY
181	457 503	RES VARI CERMET 50 K 1/2W 10%	1
182	537 103	RES VARI CERMET 10 K 3/4W 10%	8
182	537 502	RES VARI CERMET 5 K 3/4W 10%	8
208	*11 **3	IC SINGLE OP AMP LM301AN DIP-8	4
208	*74 **3	IC DIODE ARRAY CA3039 12-LEAD "TO" CAN	1
210	*40 **2	IC AMPLITUDE DISCR LD601C DIP-16	8
230	110 **5	DIODE SWITCHING 1N4448	42
230	*10 835	DIODE HOT CARRIER HP2835 H-P CASE 15	32
270	130 401	TRANSISTOR NPN A401 TO-72	16
270	180 **2	TRANSISTOR NPN PWR 2N3055 TO-3	1
270	190 **1	TRANSISTOR NPN PWR 2N3054 TO-66	1
275	150 **3	TRANSISTOR PNP 40319 TO-5	1
275	170 **2	TRANSISTOR PNP 2N5771 TO-92	12
275	190 **1	TRANSISTOR PNP PWR 2N3740 TO-66	1
300	*10 **1	BEAD SHIELDING FERRITE	24
300	*50 **1	CHOKE FERRITE SINGLE LEAD	4
400	*10 **8	SOCKET IC ST DIP-8 .300 SEP/TIN CONT/COPP-NICKEL PINS	4
400	*30 *16	SOCKET IC ST DIP-16 .300 SEP/TIN CONT/COPP-NICKEL PINS	8
402	*30 **0	CONNECTOR CO-AXIAL LEMO	33
402	*30 **1	HOOD FOR BULKHD LEMO CONN LEMO CROO.001.250	9
402	*30 **2	SPANNER NUT SMALL OD LEMO	33
402	*30 **3	GROUND LUG NONLOCK LEMO	8
405	112 **1	CONNECTOR BLOCK (PIN) 42 "MIXED"	1
405	212 **2	GUIDE PIN (MALE) CADMIUM PLATED BRASS	1
405	213 **1	GUIDE PIN (MALE) BRASS	1
405	312 **1	GUIDE PIN (FEMALE) CADMIUM PLATED BRASS	2
405	410 *16	CONNECTOR PIN (MALE)	A/R
405	613 **1	CONNECTOR HOOD CADMIUM PLATED STEEL/INT CLOSED END	1
420	212 **1	SWITCH SLIDE DPDT	1
468	911 **1	TEST POINT (JACK) WHT SKT-14 WHIT	8
500	120 **2	TRANSIPAD "LARGE"	1
540	103 102	SIDE COVER NIM LEFT	1
540	103 103	SIDE COVER NIM RIGHT	1
540	105 **1	BRACKET NIM WRAP SIZE #1	2
555	611 **1	CAPTIVE SCREW 6-32	2
555	621 **2	CAPTIVE SCREW RETAINER NICKEL PLATED BRASS	2
567	256 **4	SCREW FLAT PHIL 2-56X1/4	4
710	623 *33	PC BD PREASS'Y 623B	1
720	623 *53	FRONT PNL PREASS'Y 623B 540102001(1)555621002(2)	1
740	**0 **2	WRAPAROUND NIM 1 BIN GATE 540104101(1) PER DWG NIM-M47	1

30 110 005 24 MUST BE 1N4448

NOTE 2 253 010 835 DO NOT SUBSTITUTE

NOTE 3

NOTE 4

NOTE 5

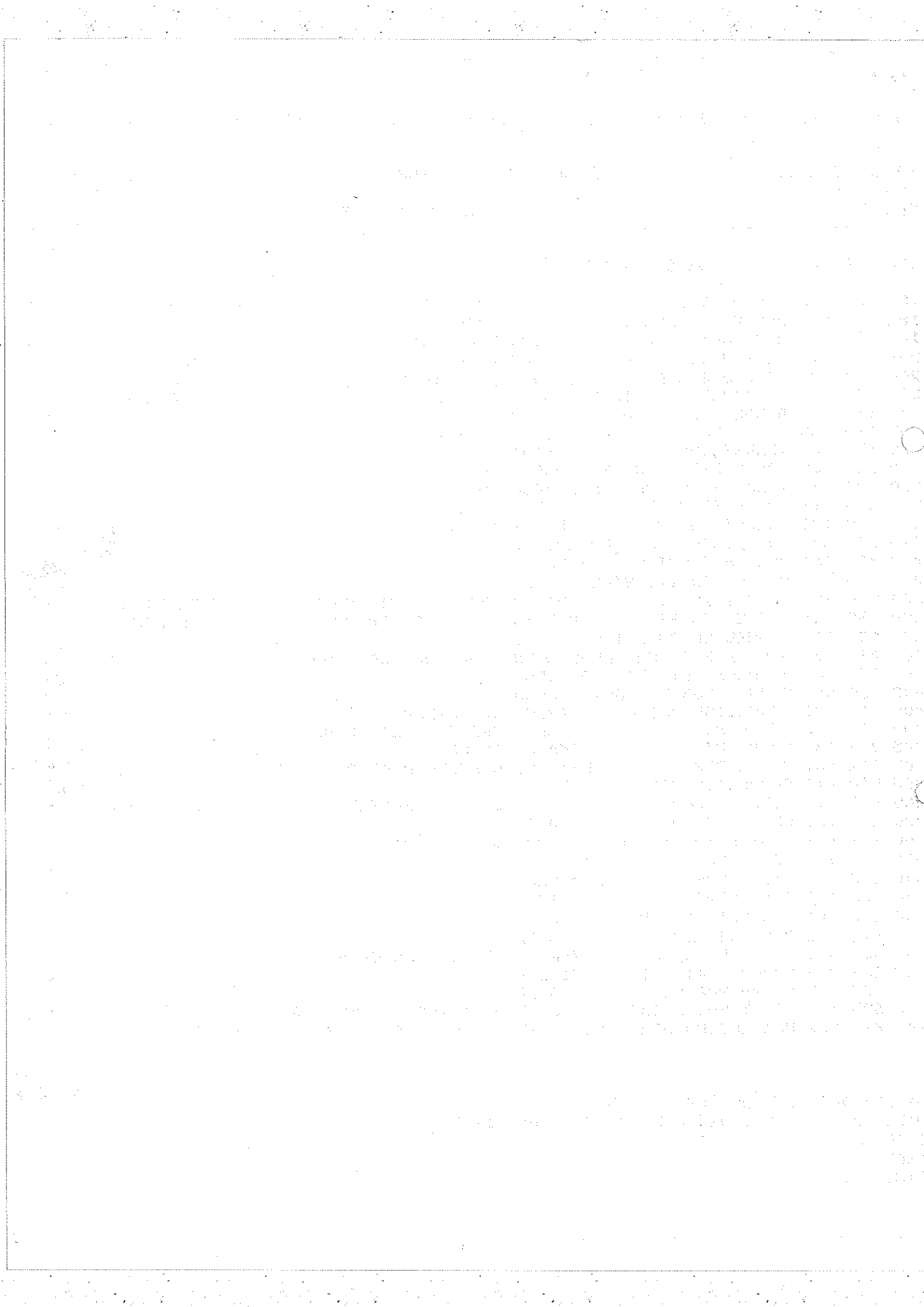



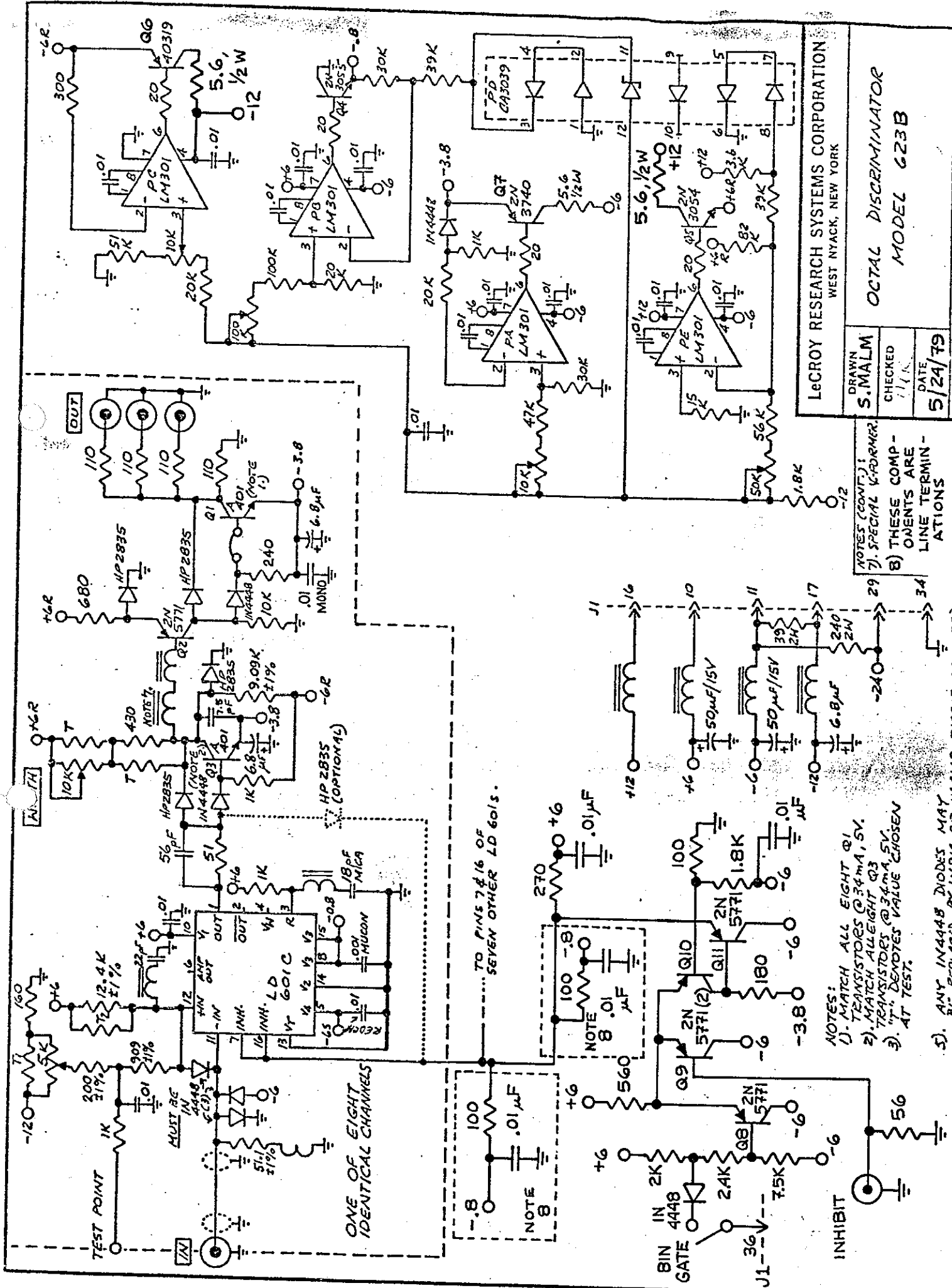

**LeCROY RESEARCH SYSTEMS CORPORATION**  
WEST NYACK, NEW YORK

DRAWN <b>S. MALM</b>	CHECKED <i>[Signature]</i>	DATE <b>5/24/79</b>
-------------------------	-------------------------------	------------------------

OCTAL DISCRIMINATOR  
MODEL 623B

DRAWING NO. 123A-S1 ECO No. 1001

NOTES (CONT.):  
 7) SPECIAL WFORMER.  
 8) THESE COMPONENTS ARE LINE TERMINATIONS

- NOTES:
- 1) MATCH ALL EIGHT Q1 TRANSISTORS @ 34mA, 5V.
  - 2) MATCH ALL EIGHT Q3 TRANSISTORS @ 34mA, 5V.
  - 3) "T" DENOTES VALUE CHOSEN AT TEST.
  - 5) ANY IN4448 DIODES MAY BE REPLACED BY IN914 OR IN4148, EXCEPT AS NOTED.
  - 6) USE 2N5962 WITH LD 601; 2N5770 WITH LD 601C.

TO PINS 7 & 16 OF SEVEN OTHER LD 601s.

ONE OF EIGHT IDENTICAL CHANNELS

NOTE 8

NOTE 8

NOTE 8

NOTE 8

NOTE 8

NOTE 8

NOTE 8

