

Technical Information Manual

Revision n. 13
17 March 2008

MOD. V775 series
MOD. V775 N series
32/16 CHANNEL
MULTIEVENT TDCs
MANUAL REV.13

NPO:
00102/97:V775x.MUTx/13

CAEN will repair or replace any product within the guarantee period if the Guarantor declares that the product is defective due to workmanship or materials and has not been caused by mishandling, negligence on behalf of the User, accident or any abnormal conditions or operations.

CAEN declines all responsibility for damages or injuries caused by an improper use of the Modules due to negligence on behalf of the User. It is strongly recommended to read thoroughly the CAEN User's Manual before any kind of operation.



CAEN reserves the right to change partially or entirely the contents of this Manual at any time and without giving any notice.

Disposal of the Product

The product must never be dumped in the Municipal Waste. Please check your local regulations for disposal of electronics products.



TABLE OF CONTENTS

1. GENERAL DESCRIPTION	9
1.1. OVERVIEW	9
1.2. BLOCK DIAGRAM.....	10
2. PRINCIPLES OF OPERATION	11
2.1. OPERATING MODE DESCRIPTION	11
2.2. TAC SECTIONS	11
2.3. ANALOG TO DIGITAL CONVERSION	13
2.4. ZERO SUPPRESSION.....	13
2.5. OVERFLOW SUPPRESSION	15
2.6. NOT VALID DATA SUPPRESSION	15
2.7. MULTIPLE EVENT BUFFER (MEB).....	16
2.8. EVENT COUNTER.....	17
2.9. BUSY LOGIC	17
2.10. RESET LOGIC.....	18
2.11. FAST CLEAR	19
3. TECHNICAL SPECIFICATIONS.....	20
3.1. PACKAGING.....	20
3.2. POWER REQUIREMENTS	20
3.3. FRONT PANEL.....	21
3.4. EXTERNAL CONNECTORS.....	23
3.4.1. <i>INPUT connectors</i>	23
3.4.2. <i>CONTROL connector</i>	23
3.4.3. <i>GATE COMMON connectors</i>	24
3.5. OTHER FRONT PANEL COMPONENTS	25
3.5.1. <i>Displays</i>	25
3.5.2. <i>Switches</i>	26
3.6. INTERNAL HARDWARE COMPONENTS	27
3.6.1. <i>Switches</i>	27
3.6.2. <i>Jumpers</i>	27
3.6.3. <i>Soldering pads</i>	29
3.7. TECHNICAL SPECIFICATIONS TABLE.....	30
4. VME INTERFACE.....	31
4.1. ADDRESSING CAPABILITY.....	31
4.1.1. <i>Addressing via Base Address</i>	31
4.1.2. <i>Addressing via geographical address</i>	32

4.1.3.	Base/GEO addressing examples.....	33
4.1.4.	MCST/CBLT addressing.....	33
4.1.5.	MCST/CBLT addressing examples.....	35
4.2.	INTERRUPTER CAPABILITY.....	37
4.2.1.	Interrupt Status/ID.....	37
4.2.2.	Interrupt Level.....	37
4.2.3.	Interrupt Generation	37
4.2.4.	Interrupt Request Release.....	37
4.3.	DATA TRANSFER CAPABILITY	37
4.4.	REGISTER ADDRESS MAP	37
4.5.	OUTPUT BUFFER.....	42
4.6.	GEO ADDRESS REGISTER	45
4.7.	MCST/CBLT ADDRESS REGISTER.....	45
4.8.	BIT SET 1 REGISTER	46
4.9.	BIT CLEAR 1 REGISTER	47
4.10.	INTERRUPT LEVEL REGISTER.....	47
4.11.	INTERRUPT VECTOR REGISTER.....	47
4.12.	STATUS REGISTER 1	48
4.13.	CONTROL REGISTER 1	49
4.14.	ADDRESS DECODER HIGH REGISTER.....	50
4.15.	ADDRESS DECODER LOW REGISTER.....	50
4.16.	SINGLE SHOT RESET REGISTER	51
4.17.	MCST/CBLT CONTROL REGISTER	51
4.18.	EVENT TRIGGER REGISTER.....	52
4.19.	STATUS REGISTER 2	52
4.20.	EVENT COUNTER_LOW REGISTER.....	53
4.21.	EVENT COUNTER_HIGH REGISTER.....	53
4.22.	INCREMENT EVENT REGISTER	54
4.23.	INCREMENT OFFSET REGISTER.....	54
4.24.	FAST CLEAR WINDOW REGISTER	54
4.25.	BIT SET 2 REGISTER	55
4.26.	BIT CLEAR 2 REGISTER	57
4.27.	W MEMORY TEST ADDRESS REGISTER	57
4.28.	MEMORY TEST WORD_HIGH REGISTER.....	57
4.29.	MEMORY TEST WORD_LOW REGISTER.....	58
4.30.	CRATE SELECT REGISTER.....	58
4.31.	TEST EVENT WRITE REGISTER	58
4.32.	EVENT COUNTER RESET REGISTER	59
4.33.	FULL SCALE RANGE REGISTER	59

4.34.	R MEMORY TEST ADDRESS REGISTER	60
4.35.	SW COMM REGISTER	61
4.36.	SLIDE CONSTANT REGISTER	61
4.37.	AAD REGISTER	61
4.38.	BAD REGISTER	61
4.39.	THRESHOLDS MEMORY	62
4.40.	ROM MEMORY	62
5.	OPERATING MODES	64
5.1.	INSTALLATION	64
5.2.	POWER ON SEQUENCE	64
5.3.	POWER ON STATUS	65
5.4.	OPERATION SEQUENCE	66
5.5.	TEST MODES	67
5.5.1.	<i>Random Memory Access Test Mode</i>	67
5.5.2.	<i>Acquisition Test Mode</i>	67
5.6.	BLOCK TRANSFER MODE	69
5.7.	ADVANCED SETTING AND READOUT MODES	70
5.7.1.	<i>Chained Block Transfer Mode</i>	70
5.7.2.	<i>Multicast Commands</i>	71
APPENDIX A	72
	<i>VME INTERFACE TIMING</i>	72
A.1	VME CYCLE TIMING IN D16/D32 MODE	73
A.2	VME CYCLE TIMING IN BLT / CBLT MODE	73
A.3	VME CYCLE TIMING IN MBLT / CBLT64 MODE	74
6.	REFERENCES	75

LIST OF FIGURES

FIG. 1.1: MODEL TYPE LABEL (EXAMPLE: V775AC)	9
FIG. 1.2: MODEL V775 (32 CHANNEL) BLOCK DIAGRAM	10
FIG. 2.1: SIMPLIFIED BLOCK DIAGRAM OF THE TAC SECTION	11
FIG. 2.2: SIGNAL CONVERSION TIMING IN COMMON STOP MODE	12
FIG. 2.3: BLOCK DIAGRAM OF THE SLIDING SCALE SECTION	13
FIG. 2.4: ZERO SUPPRESSION (BIT 8 OF BIT SET 2 REGISTER = 0, DEFAULT SETTING)	14
FIG. 2.5: ZERO SUPPRESSION (BIT 8 OF BIT SET 2 REGISTER = 1)	14
FIG. 2.6: TAC AUTORESET IN COMMON STOP MODE	15
FIG. 2.7: MULTI-EVENT BUFFER: WRITE POINTER AND READ POINTER	16
FIG. 2.8: FAST CLEAR WINDOW	19
FIG. 3.1: MODEL V775 FRONT PANEL	21
FIG. 3.2: MODEL V775 N FRONT PANEL	22
FIG. 3.3: CONTROL CONNECTOR PIN ASSIGNMENT (V775 ONLY)	25
FIG. 3.4: V775 COMPONENT LOCATION (COMPONENT SIDE)	28
FIG. 3.5: COMPONENTS LOCATION (SOLDERING SIDE)	29
FIG. 4.1: BINARY-HEXADECIMAL REPRESENTATION OF THE BOARD ADDRESS IN GEO MODE	32
FIG. 4.2: BINARY-HEXADECIMAL REPRESENTATION OF BIT SET 1 REGISTER ADDRESS IN GEO MODE	32
FIG. 4.3: BASE/GEO ADDRESSING: EXAMPLE 1	33
FIG. 4.4: MCST/CBLT ADDRESSING EXAMPLE	35
FIG. 4.5: OUTPUT BUFFER: THE HEADER	42
FIG. 4.6: OUTPUT BUFFER: THE DATA WORD FORMAT	42
FIG. 4.7: OUTPUT BUFFER: THE END OF BLOCK	42
FIG. 4.8: OUTPUT BUFFER: NOT VALID DATUM	44
FIG. 4.9: MULTI-EVENT BUFFER: DATA STRUCTURE EXAMPLE	44
FIG. 4.10: GEOGRAPHICAL ADDRESS REGISTER	45
FIG. 4.11: MCST/CBLT ADDRESS REGISTER	46
FIG. 4.12: BIT SET 1 REGISTER	46
FIG. 4.13: INTERRUPT LEVEL REGISTER	47
FIG. 4.14: INTERRUPT VECTOR REGISTER	48
FIG. 4.15: STATUS REGISTER 1	48
FIG. 4.16: CONTROL REGISTER 1	49
FIG. 4.17: ADER HIGH REGISTER	50
FIG. 4.18: ADER LOW REGISTER	51
FIG. 4.19: MCST ADDRESS REGISTER	51

FIG. 4.20: EVENT TRIGGER REGISTER	52
FIG. 4.21: STATUS REGISTER 2	52
FIG. 4.22: EVENT COUNTER LOW REGISTER.....	53
FIG. 4.23: EVENT COUNTER HIGH REGISTER.....	54
FIG. 4.24: FAST CLEAR WINDOW REGISTER.....	55
FIG. 4.26: BIT SET 2 REGISTER	55
FIG. 4.27: W MEMORY TEST ADDRESS REGISTER.....	57
FIG. 4.28: TEST WORD_HIGH REGISTER	58
FIG. 4.29: TEST WORD_LOW REGISTER	58
FIG. 4.30: CRATE SELECT REGISTER	58
FIG. 4.31: TEST EVENT WRITE REGISTER	59
FIG. 4.32: FULL SCALE RANGE REGISTER	59
FIG. 4.33: LSB Vs. FULL SCALE RANGE REGISTER SETTING.....	60
FIG. 4.34: R MEMORY TEST ADDRESS REGISTER	60
FIG. 4.35: SLIDE CONSTANT REGISTER.....	61
FIG. 4.36: AAD REGISTER	61
FIG. 4.37: BAD REGISTER.....	61
FIG. 4.38: THRESHOLD REGISTER	62
FIG. A.1: VME CYCLE TIMING IN D16 MODE.....	73
FIG. A.2: VME CYCLE TIMING IN BLT/CBLT MODE.....	73
FIG. A.3: VME CYCLE TIMING IN MBLT/CBLT64 MODE	74

LIST OF TABLES

TABLE 1.1: VERSIONS AVAILABLE FOR THE MODEL V775	9
TABLE 3.1: MODEL V775 POWER REQUIREMENTS.....	20
TABLE 3.2 : MODEL V775 TECHNICAL SPECIFICATIONS	30
TABLE 4.1: MODULE RECOGNISED ADDRESS MODIFIER.....	31
TABLE 4.2: ADDRESS MAP FOR THE MODEL V775.....	40
TABLE 4.3: ADDRESS MAP IN CBLT OPERATION	41
TABLE 4.4: ADDRESS MAP IN MCST OPERATIONS.....	41
TABLE 4.5: ROM ADDRESS MAP FOR THE MODEL V775.....	63

1. General description

1.1. Overview

The **Model V775** is a 1-unit wide VME 6U module housing 32 Time-to-Digital Conversion channels. The Full Scale Range can be selected via VME from 140 ns to 1.2 μ s with 8 bit resolution. The board can operate both in COMMON START and in COMMON STOP mode. Each time interval between the COM signal and the input signal is converted to a voltage level by the TAC sections. The outputs of the TAC sections are multiplexed and subsequently converted by two fast ADC modules (5.7 μ s conversion time). The **Model V775 N** houses 16 channels on LEMO 00 connectors and shares most of its features with the Mod. V775. Several versions are available, refer to Table 1.1.

Programmable zero suppression, multievent buffer memory, trigger counter and test features complete the flexibility of the unit. The module works in A24/A32 mode. The data transfer occurs in D16, D32, BLT32 or MBLT64 mode. The unit supports also the Chained Block Transfer and the Multicast commands.

Table 1.1: Versions available for the Model V775

Version ¹	Number of channels	PAUX connector ²	-5 V DC-DC converter	Live insertion
V775 AC	32	no	yes	no
V775 NC	16	no	yes	no



Fig. 1.1: Model type label (example: V775AC)

¹ A label on the printed board soldering side indicates the module's version (see Fig 1.1); all the versions share the same features except where indicated.

² The version with the PAUX connector requires the V430 backplane.

1.2. Block diagram

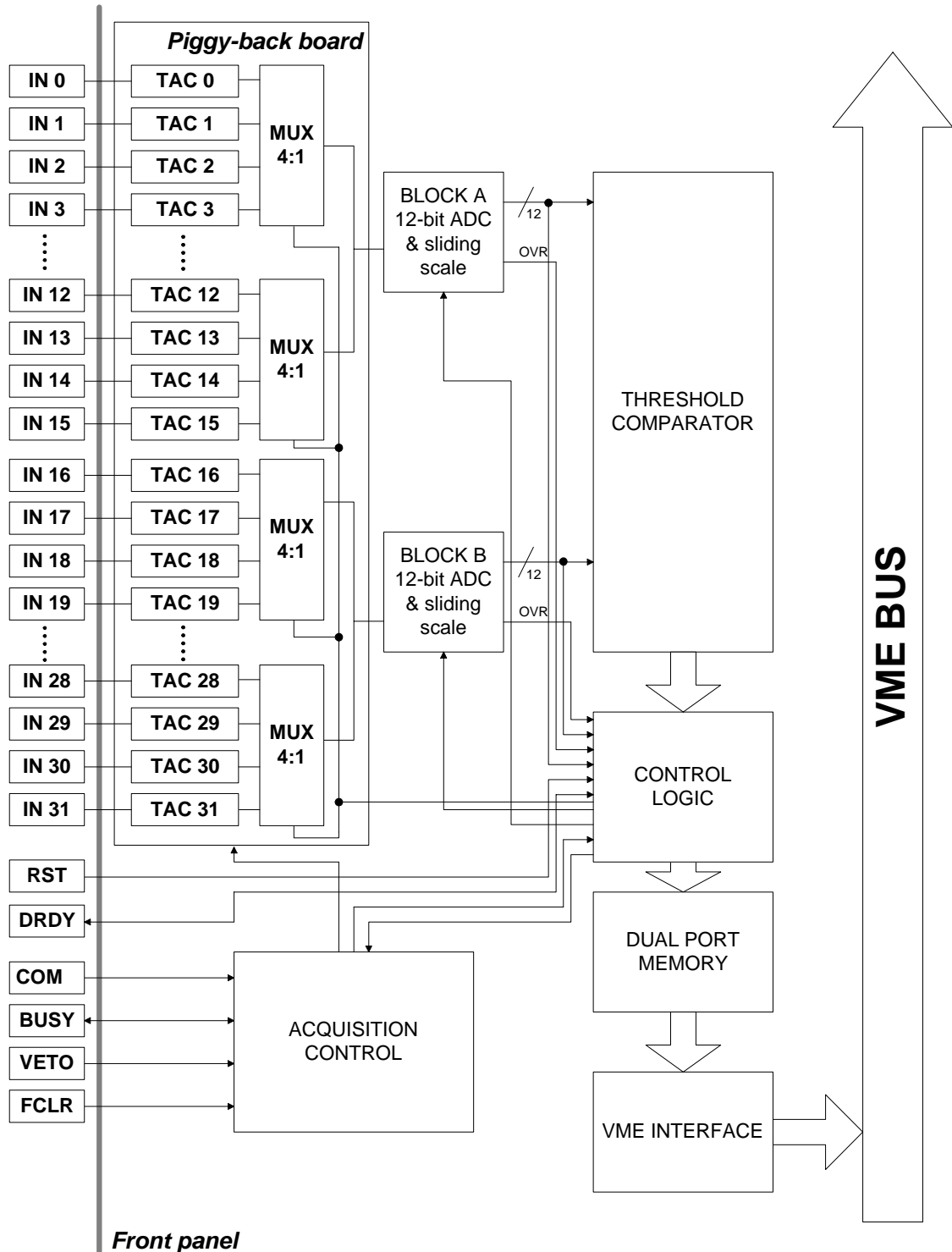

Fig. 1.2: Model V775 (32 channel) Block Diagram

2. Principles of operation

The board has 32 (16 for the Mod. V775 N) channel inputs and one COM input (ECL/NIM) common to all channels. The Mod. V775 N does not feature the ECL GATE input.

The time intervals between the input and COM signals are converted into a voltage level by the TAC sections and then are multiplexed and converted by two fast 12-bit ADC modules.

Only the values that are above a programmable threshold (see § 2.4), do not cause overflow (see § 2.5) and are not killed (see § 2.4) will be stored in a dual port data memory accessible via VME.

In the following functional sections and operation principles of the module are described in some detail. The block diagram of the module can be found in Fig. 1.2.

2.1. Operating mode description

The Mod. V775 can operate either in Common Start or Common Stop mode. The operating mode can be selected via the bit 10 of the Bit set 2 register (please refer to § 4.25).

2.2. TAC sections

The module hosts 32 (16 for the Mod. V775 N) TAC (Time to Amplitude Conversion) sections; a TAC section converts the time interval between Start and Stop signals to a proportional voltage level (a simplified block diagram is reported in Fig. 2.1). A Start signal closes the switch SW1 thus allowing a constant current to flow through an integrator; a Stop signal opens the switch SW1 again. The constant current generates a linear ramp voltage which is stopped at an amplitude proportional to the time interval between Start and Stop pulses. After digitisation the SW2 switch is closed by the CLEAR signal which allows the discharge of the capacitor C1. Both the COMMON and CLEAR signals are controlled by the CONTROL LOGIC section. The timing of signals during data acquisition is shown in Fig. 2.2.

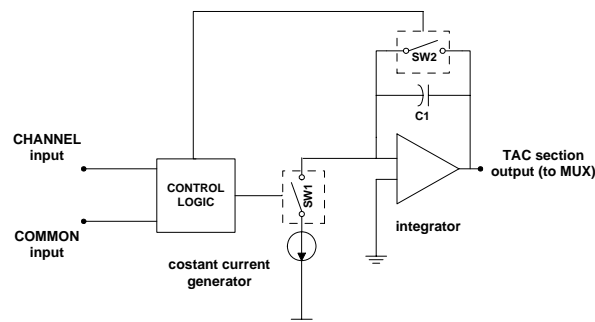

Fig. 2.1: Simplified block diagram of the TAC section

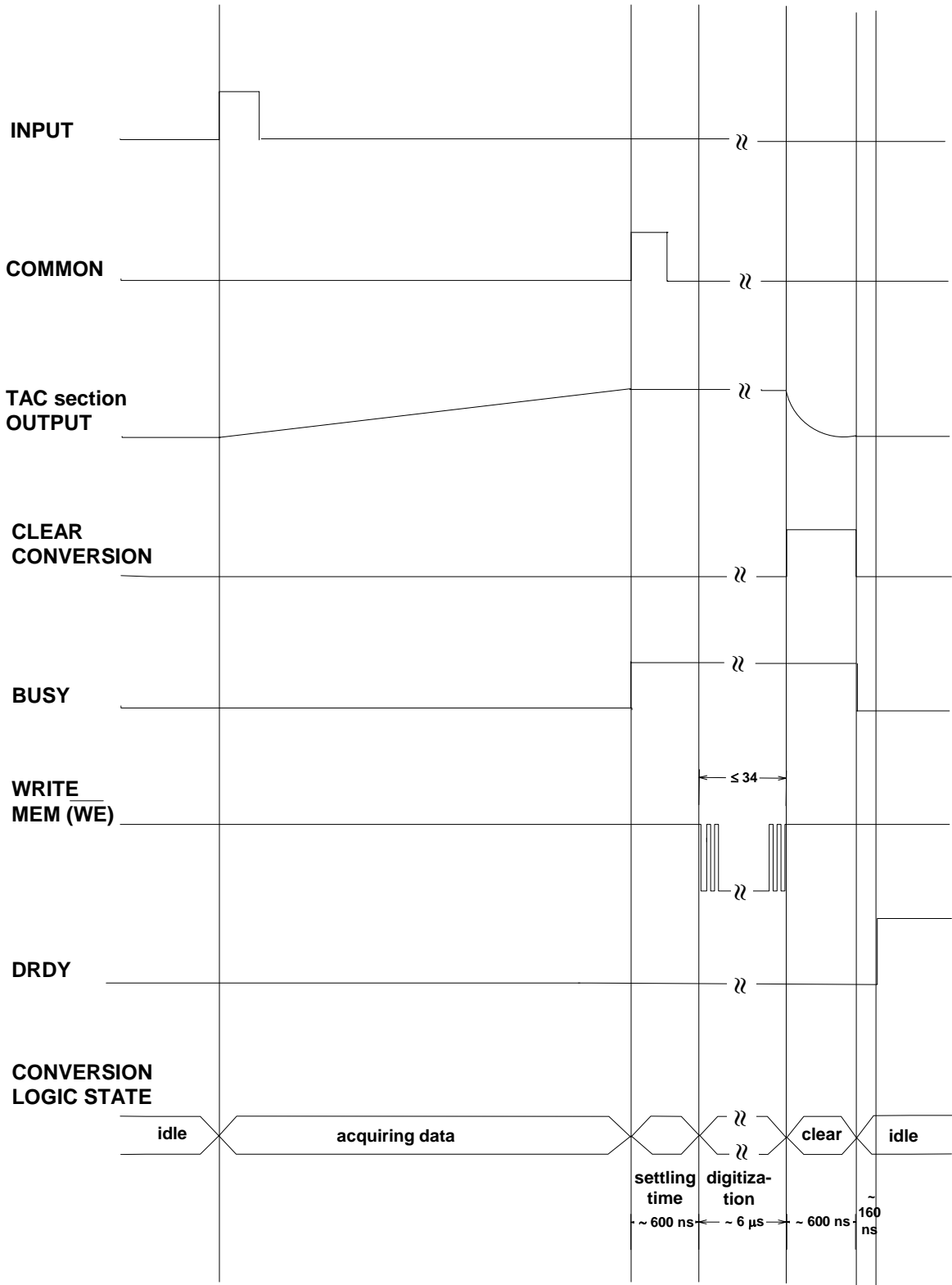

Fig. 2.2: Signal conversion timing in Common Stop mode

2.3. Analog to digital conversion

The output of each TAC section is multiplexed, by group of 4 channels, and subsequently converted by two fast 12 bit ADCs, each of which operates the conversion on a group of 16 channels (Block A and Block B ADCs). The ADCs conversion time is 5.7 μ s for the V775 and 2.8 μ s for the V775 N, regardless the number of active channels (see block diagram in Fig. 1.2).

The ADC section supports the sliding scale technique to reduce the differential non-linearity (see references [1], [2]). This technique (see Fig. 2.3) consists in adding a known value to the analog level to be converted, thus spanning different ADC conversion regions with the same analog value. The known level is then digitally subtracted after the conversion and the final value is sent to the threshold comparator.

If the sliding scale is enabled, it reduces slightly the dynamic range of the ADC: the 12 bit digital output is valid from 0 to 3840, while the values from 3841 to 4095 are not correct.

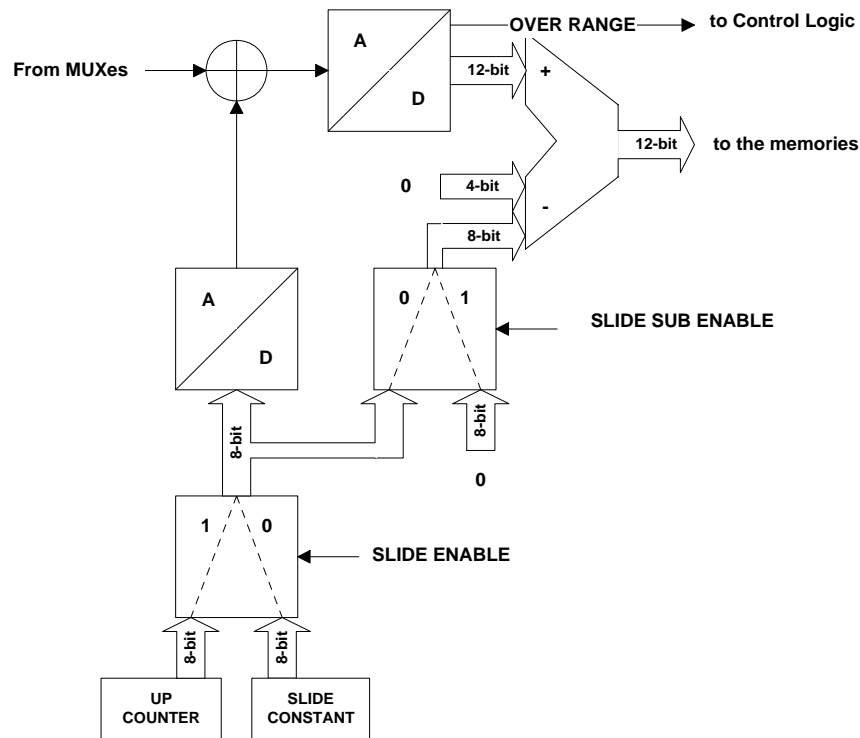

Fig. 2.3: Block diagram of the sliding scale section

2.4. Zero suppression

The output of the ADC is fed to a threshold comparator to perform the zero suppression. If the converted value from a channel is greater than (or equal to) the relevant low threshold value set via VME in the Thresholds memory (Base Address + 0x1080 ÷ 0x10BF, see § 4.39), the result is fed to the dual port memory and will be available for the readout.

If the converted value is lower than the threshold, the value is stored in the memory only if the LOW TRESHOLD PROG. bit of the Bit Set 2 Register is set to 1 (see § 4.25). The fact that the converted value was under the threshold is also flagged in the datum stored in the memory, where the bit 13 (UNDERTHRESHOLD) of the 16-bit data word is set to 1 (see § 4.5). The Thresholds memory allows to set a low threshold value for each channel. Default setting corresponds to thresholds not defined. By setting the bit 8 in the Bit Set 2 Register it is possible to program the Threshold values in 16 ADC counts steps over the entire full scale range or in 2 ADC counts steps over 1/8 of full scale range*. In more detail, if Bit 8 = 0 (default value) the comparison is performed between the 8 MSB of each 12 bit converted value and the 8 bit threshold value which is stored in the relevant register as illustrated in Fig. 2.5. The threshold values can be programmed over the entire full scale range.

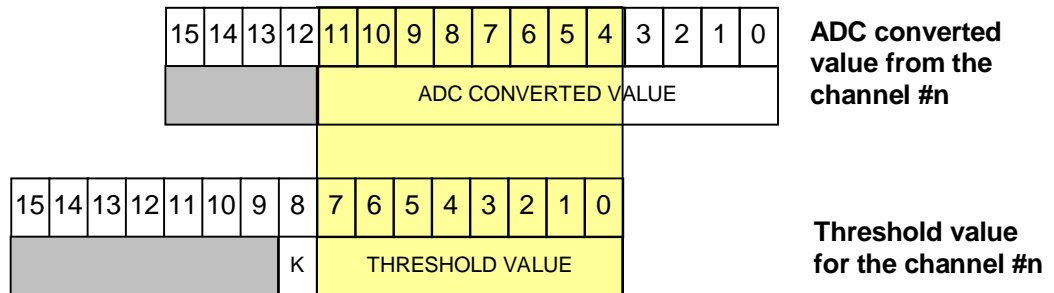

Fig. 2.4: Zero suppression (Bit 8 of Bit Set 2 Register = 0, default setting)

if Bit 8 = 1 (in the Bit Set 2 Register) the comparison is performed between the bit 1...8 of each 12 bit converted value and the 8 bit threshold value which is stored in the relevant register as illustrated in the figure below (converted value is under threshold if the value written in the 1...8 bits is smaller than the threshold value and 9...11 bits are 0). The threshold values can be programmed over 1/8 of full scale range.

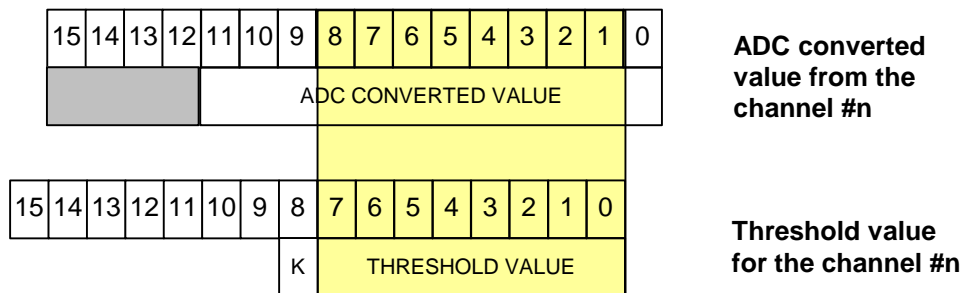

Fig. 2.5: Zero suppression (Bit 8 of Bit Set 2 Register =1)

The comparison is resumed in the following table:

STEP_TH Bit (Bit 8 of Bit Set 2 Register)*	Comparison
1	ADC CONVERTED VALUE < THRESHOLD VALUE x 2
0	ADC CONVERTED VALUE < THRESHOLD VALUE x 16

* This feature is available from firmware releases 5.1; for earlier firmware releases the thresholds can be programmed only in 16 ADC counts steps (as illustrated in Fig. 2.4).

If the result of the comparison is true and the Bit 4 (LOW THRESHOLD PROG) of the Bit Set 2 Register is set to 0, data are skipped. If the Bit 4 of the Bit Set 2 Register is set to 1, the true result of the comparison is signalled by Bit 13 (UNDERTHRESHOLD) = 1 in the loaded data 16 bit word.

The content of the Threshold Register includes also a KILL bit, which allows to abort the memorisation of the datum even if it is higher than the threshold set in the register. This bit can thus be used to disable some channels. Refer to § 4.39 for further details.

The threshold values are lost only after switching the board off (a reset operation does not affect the threshold values).

2.5. Overflow suppression

The overflow suppression allows to abort the memorisation of data which originated an ADC overflow. The control logic provides to check if the output of the ADC is in overflow and, in the case, the value is not stored in the memory.

The overflow suppression can be disabled by means of the OVER RANGE PROG bit of the Bit Set 2 Register (see § 4.25): if this bit is set to 1, all the data, independently from the fact that they caused ADC overflow or not, are stored in the memory. In this case, the 16-bit word stored in the memory will have the bit 12 (OVERFLOW) set to 1 (see § 4.5)

2.6. Not valid data suppression

When the module works in Common Stop mode, it may occur that a TAC output saturates before the arrival of a Stop signal; in this case the TAC section resets itself through constant current capacitor discharge and after approximately 700 ns the channel is ready to accept a new Start signal. If a Stop signal arrives when the TAC is resetting the datum is not valid (this condition is flagged by the bit 14 of the data word (see § 4.5)).

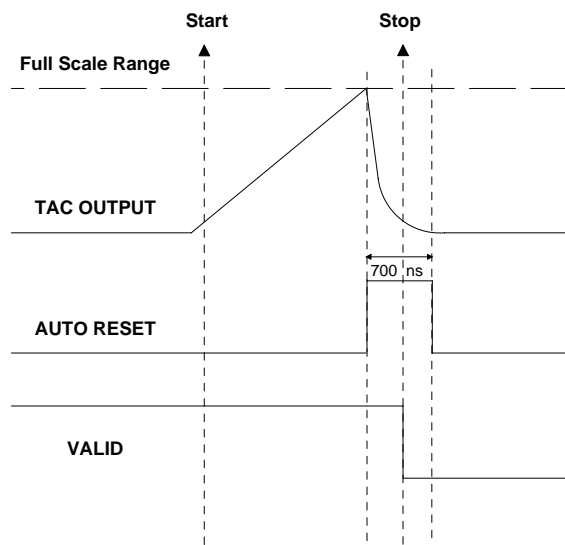

Fig. 2.6: TAC autoreset in Common Stop mode

The not valid data suppression can be disabled by means of the VALID CONTROL bit of the Bit Set 2 Register (see § 4.25): if this bit is set to 1, all the data, are however stored in the memory.

2.7. Multiple Event Buffer (MEB)

After the conversion, if there is at least one converted value above the programmed threshold, not causing overflow and not killed, the control logic stores it in the Multi-Event Buffer (MEB). The Multi-Event Buffer is a Dual Port FIFO Memory (34 Words/event) which can store up to 32 events. It is available at the VME address: Base Address + 0x0000÷0x0FFC (see also § 4.5).

In order to trace the event flow, two pointers (Read and Write pointer) are employed. The Read Pointer points to the active read buffer. The Write pointer is incremented automatically via hardware at the end of the channels conversion, while the Read pointer can be either incremented automatically (AUTO INCR. bit of the Bit Set 2 Register set to 1; see § 4.25) or via write access to one of two dummy registers, Increment Event and Increment Offset Registers (see § 4.22 and 4.23). These allow to move the readout pointer to the next event in the output buffer or to the next word, respectively.

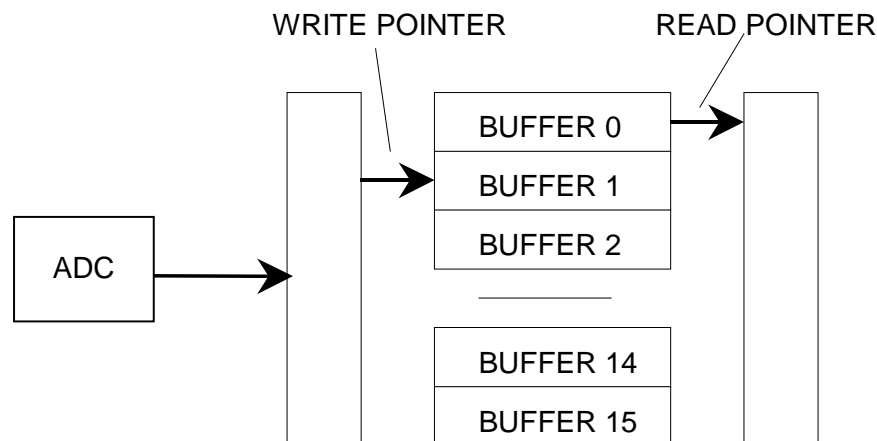

Fig. 2.7: Multi-Event Buffer: Write pointer and Read pointer

The MEB can be either in a "Full", a "Not empty" or an "Empty" status.

When the 5MSB of the Read pointer and the 5MSB of the Write pointer are different (i.e. point to different events), the MEB is in a "Not empty" status.

When the Read pointer and the Write pointer are equal, the MEB can be either in a "Full" or an "Empty" status. The MEB is full or empty according to the last increment pointer operation performed: if the last increment is the one of the Write pointer, the MEB is Full; if the last increment is the one of the Read pointer, the MEB is Empty.

The status of the MEB is monitored via two Registers, the Status Register 1 and the Status Register 2 (see § 4.12 and § 4.19, respectively).

After the conversion, the accepted data (i.e. the converted values above the programmed threshold, not causing overflow and not killed) are stored in the active event buffer (i.e. the one pointed by the write pointer) in subsequent 32-bit words. These are organised in

events. Each event consists of a Header (see Fig. 4.5), a block of data words (Fig. 4.6) and an End-Of-Block (EOB) word (Fig. 4.7).

Each event contains thus from a minimum of 3 32-bit words (Header, one data word and EOB) to a maximum of 34 32-bit words (Header, 32 data words and EOB).

In case there are no accepted data, the user can choose to store anyway in the MEB the Header and the EOB relative to the event (see EMPTY PROG bit of the Bit Set 2 Register, see § 4.25): in this case the event is constituted by 2 32-bit words only.

The MEB is mapped on a 2 Kbyte wide address space to facilitate BLT across 256 byte boundaries with some brands of CPUs but it is important to point out that any read operation at any location within the segment Base Address + 0x0000÷0x0FFC, always returns the data word pointed by the Read Pointer

2.8. Event Counter

The module houses a 24-bit counter that counts the number of COMMON signals that the module has received.

The Event Counter can work in two different modes, which can be selected via the Bit 14 (ALL TRG) of the Bit Set 2 Register (see § 4.25):

Mode A (ALL TRG = 1): it counts all events (default);
Mode B (ALL TRG = 0): it counts only the accepted events.

In the first case (Mode A), the Event Counter is increased each time a pulse is sent through the COMMON input.

In the second case (Mode B), the Event Counter is increased each time a pulse, sent through the COMMON input, is accepted (i.e. VETO, FCLR and BUSY are not active).

The value of the Event Counter is stored in the EOB of the Multi-Event Buffer (see § 4.5). The Event Counter is also stored in two registers, the Event Counter_Low and Event Counter_High Registers, which respectively contain the 16LSBs and the 8MSBs of the Event Counter (see § 4.20 and § 4.21).

2.9. Busy Logic

The board is BUSY either during the conversion sequence or during the reset of the analog section or when the MEB is not ready to accept data (MEB Full) or when the board is in Random Memory Access Test mode (see § 5.5.1).

On the occurrence of one of these conditions the front panel BUSY signal (CONTROL bus) is active, the red BUSY LED is on and the bit 2 (BUSY) and bit 3 (GLOBAL BUSY) of the Status Register 1 are set to 1 (see § 4.12).

The BUSY LED lights up also while the board is configuring (power ON).

Actually, each module sets to 1 its BUSY output after the leading edge of a pulse on the COMMON input (module busy) and releases it to 0 at the end of the conversion sequence. When the module is busy, it does not accept another COMMON pulse.

The jumper J12 placed on the PCB (see Fig. 3.4) allows to select board behaviour in response to a BUSY status: if this jumper is set to EXTBSY, the acquisition is stopped as

soon as any of the boards on the Control bus is BUSY; if the jumper is set to INTBSY, acquisition is stopped as the board is BUSY.

2.10. Reset Logic

Three different types of RESET operations can be distinguished, according to the effects they have on the module and particularly on the registers. These are:

- *Type A:* Data RESET
- *Type B:* Software RESET
- *Type C:* Hardware RESET

The **Data RESET** clears the data in the output buffer, resets the read and write pointers, the event counter and the TAC sections. It does not affect the registers.

This type of RESET can be forwarded in two ways:

1. setting the Bit 2 (CLEAR DATA) of the Bit Set 2 Register to 1 (see § 4.25); the Reset is released via the Bit Clear 2 Register (see § 4.26);
2. sending a RESET pulse from the front panel with the Bit 4 (PROG RESET) of the Control Register 1 set to 0 (see § 4.13).

The **Software RESET** performs the same actions as the data RESET and, moreover, it resets the registers marked in the column SR (Software Reset) in Table 4.2.

This type of RESET can be forwarded in three ways:

1. setting the Bit 7 (SOFTWARE RESET) of the Bit Set 1 Register to 1 (see § 4.8): this sets the module to a permanent RESET status which is released only via write access, with the relevant bit set to 1, to the Bit Clear 1 Register;
2. sending a RESET pulse from the front panel with the Bit 4 (PROG RESET) of the Control Register 1 set to 1 (see § 4.13);
3. performing a write access to the Single Shot Reset Register (see § 4.16): the RESET lasts as long as the write access itself.

The **Hardware RESET** performs the same actions as the Software RESET and, moreover, it resets further registers. All the registers reset by a Hardware RESET are marked in the column HR (Hardware Reset) in Table 4.2.

This type of RESET is performed:

1. at Power ON of the module;
2. via a VME RESET (SYS_RES).

At power ON or after a reset the module must thus be initialised.

2.11. FAST CLEAR

The FAST CLEAR of the module can be performed via the relevant front panel signal (see § 3.4.2). A FAST CLEAR signal, generated at any time within the FAST CLEAR window, i.e. between the leading edge of the COMMON signal and the end of the programmable time value set in the Fast Clear Window Register (see § 4.24), aborts the conversion. Its minimum width must be 10 ns.

N.B.: since a FAST CLEAR operation implies a CLEAR CONVERSION cycle, a new GATE signal is accepted only if it occurs at least 600 ns after the leading-edge of the FAST CLEAR signal.

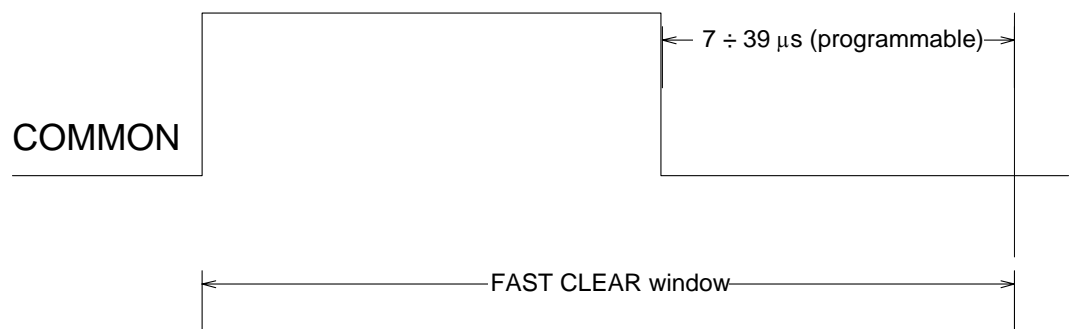

Fig. 2.8: Fast Clear window

3. Technical specifications

3.1. Packaging

The Model V775 is housed in a 6U-high, 1U-wide VME unit. The board hosts the VME P1, P2 connectors.

3.2. Power requirements

The power requirements of the versions available for the V775 module are as follows:

Table 3.1: Model V775 power requirements

Power supply	Mod. V775AC	Mod. V775NC
+12 V	570 mA	700 mA
-12 V	350 mA	600 mA
+5 V	5650 mA	4700 mA

3.3. Front Panel

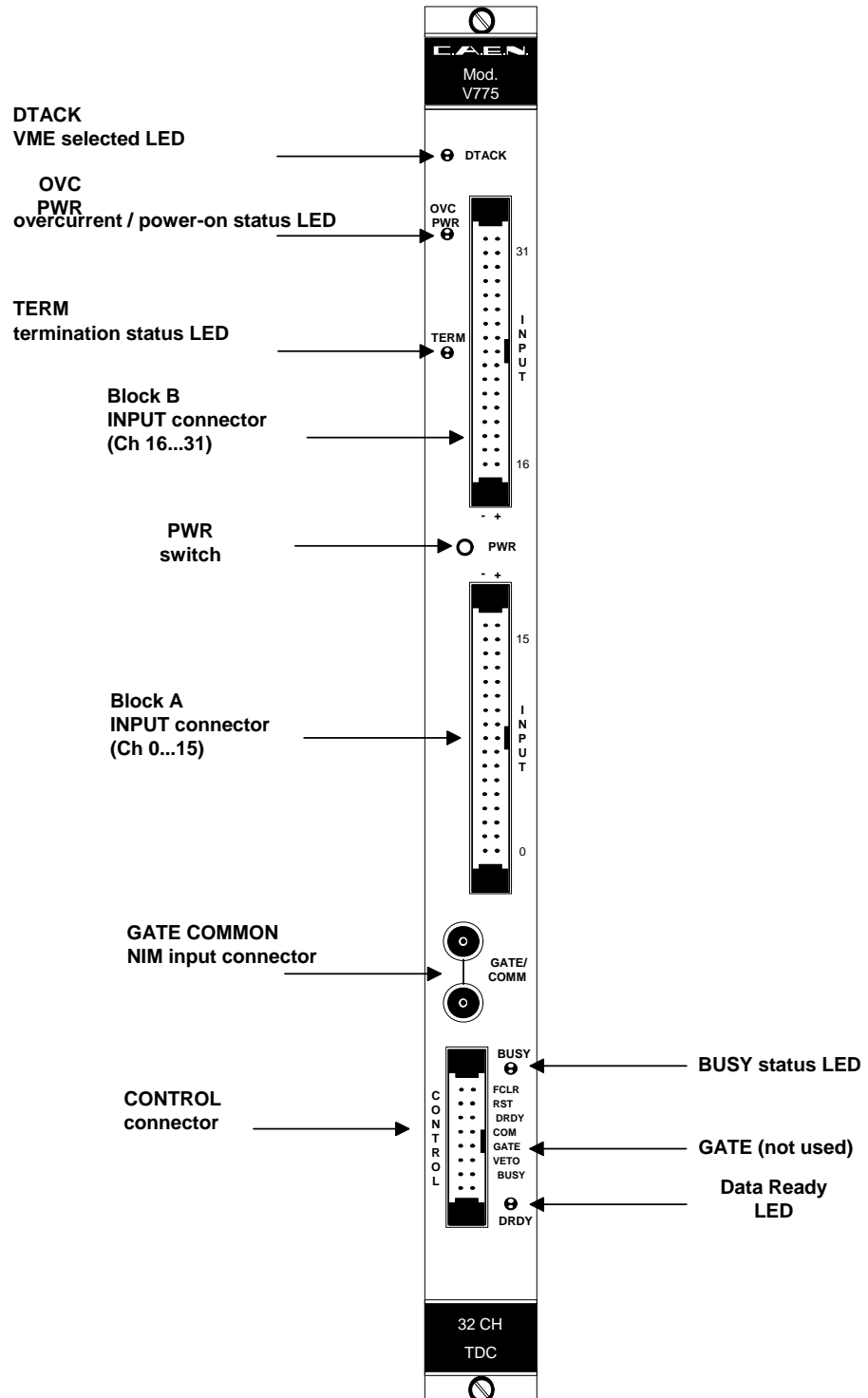

Fig. 3.1: Model V775 front panel

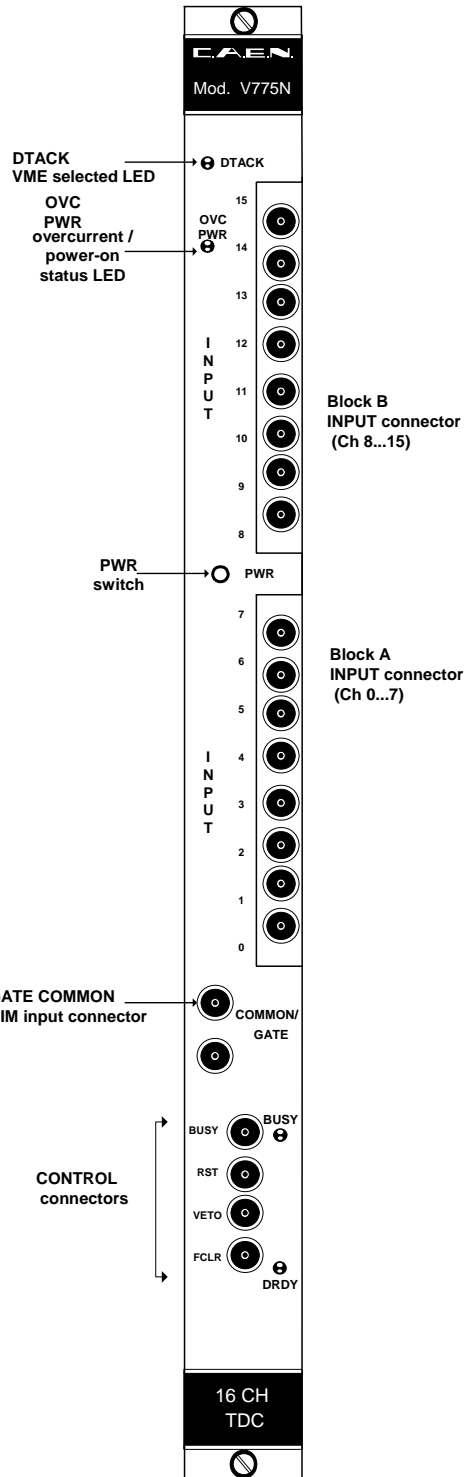

Fig. 3.2: Model V775 N front panel

3.4. External connectors

The location of the connectors is shown in Fig. 3.1. Their function and electro-mechanical specifications are listed in the following subsections.

3.4.1. INPUT connectors

Mod. V775:

Mechanical specifications:

two 17+17-pin, 3M 3431-5202 Header-type connectors.

Electrical specifications:

ECL input signals, 110 Ω impedance. The 17th higher pair of pins of each connector is not connected.

BLOCK A INPUT: input signals from channel 0 through channel 15.

BLOCK B INPUT: input signals from channel 16 through channel 31.

Mod. V775 N:

Mechanical specifications:

16 LEMO 00 connectors.

Electrical specifications:

NIM input signals, 50 Ω impedance.

BLOCK A INPUT: input signals from channel 0 through channel 7.

BLOCK B INPUT: input signals from channel 8 through channel 15.

3.4.2. CONTROL connector

Mod. V775:

Mechanical specifications:

two 8+8-pin, 3M 3408-5202 Header-type connectors.

Pin assignment is shown in Fig. 3.3. The 1st lower pair of pins is not connected: they can be optionally connected to VEE (-5 V) or to DIGITAL GND by means of a soldering pad on the Printed Circuit Board. Refer to § 3.6.3 for further details.

All the control lines described below can be 110 Ω terminated on-board via internal DIP-switches, please refer to § 3.5.2 for further details

FCLR: *Electrical specifications:* diff. ECL input signal, active-high; high impedance; min. width: 10 ns.

Function: FAST CLEAR signal, accepted if sent within the so-called FAST CLEAR window (see Fig. 2.8); it clears the TAC sections of the unit and aborts completely the conversion in progress.

RST: *Electrical specifications:* diff. ECL input signal, active-high; high impedance; min. width: 10 ns.

Function: clears the TAC sections, resets the Multi-Event Buffer status, stops pending ADCs conversions and,

depending on the user's settings (see PROG RESET, § 4.13), may clear the control registers.

- DRDY:** *Electrical specifications:* diff. ECL input/output signal; high impedance.
Function: indicates the presence of data in the output buffer of the board; DATA READY status is also flagged by the bit 0 of the Status Register 1; when several boards are daisy-chained, the global OR and NAND of DATA READY signals can be read respectively on the DRDY+ and DRDY- lines of the CONTROL bus and the status of the DRDY+ bidirectional line is flagged by the bit 1 of the Status Register 1 (see § 4.12)
- GATE:** (not used).
- COM:** *Electrical specifications:* diff. ECL input signal, active-high; high impedance; min. width: 10 ns
Function: Common Start or Common Stop signal.
- VETO:** *Electrical specifications:* diff. ECL input signal, active-high; high impedance.
Function: inhibits the conversion of the detected signals.
- BUSY:** *Electrical specifications:* diff. ECL output signal; high impedance.
Function: indicates that the board is either converting or resetting or in MEMORY TEST mode or the MEB is full, BUSY status is also flagged by the bit 2 of the Status Register 1; when several boards are daisy-chained, the global OR and NAND of BUSY signals can be read respectively on the BUSY+ and BUSY- lines of the CONTROL bus and the status of the BUSY+ bidirectional line is flagged by the bit 3 of the Status Register 1 (see § 4.12)

The **Mod. V775 N** features BUSY, RST, FCLR and VETO as standard NIM logic signals (high impedance) on a LEMO 00 connector each; function and width of the control signals are the same as for the Mod. V775.

3.4.3. GATE COMMON connectors

Mechanical specifications:
two 00-type LEMO connectors.

Electrical specifications:
NIM std. input signals; high impedance; min. width: 10 ns. If this input is used, a 50 Ω termination is required; in daisy-chain configuration, the termination must be inserted on the last board of the chain.

- GATE/COMM:** *Function:* Start or Stop input signal, common to all channels. In the Mod. V775 this signal is internally OR-wired with the COMMON of the CONTROL connector.

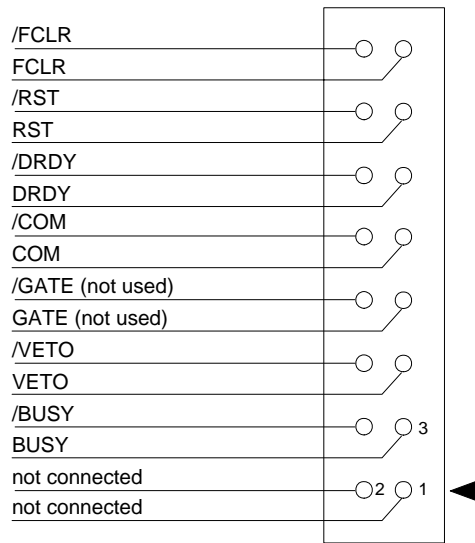

Fig. 3.3: CONTROL connector pin assignment (V775 only)

3.5. Other front panel components

3.5.1. Displays

The front panel (refer to Fig. 3.1) hosts the following LEDs:

- DTACK:** *Colour:* green.
Function: DATA ACKNOWLEDGE command; it lights up each time a VME access is performed.
- BUSY:** *Colour:* red.
Function: it lights up each time the module is performing a conversion or resetting the analog section or in memory TEST mode or when the Multi-Event Buffer is full; it also lights up for a while at power ON to indicate that the board is configuring.
- DRDY:** *Colour:* yellow.
Function: it lights up when at least one event is present in the output buffer; it also lights up for a while at power ON to indicate that the board is configuring.
- TERM:** *Colour:* orange/green/red.
Function: it lights up green when all the lines of the control bus are terminated, red when no line of the control bus is terminated. If only some lines are terminated, it is off. It also lights up orange for a while at power ON to indicate that the board is configuring.
- OVC/PWR:** *Colour:* green/orange.
Function: it lights up green when the board is inserted into the crate and the crate is powered up; when it is orange, it indicates that there is an over-current status: in this case,

remove the overload source, switch the module off and then switch it on again.

3.5.2. Switches

PWR:

Type: miniature flush plunger push-button switch.

Function: after the insertion of the board into the crate, it allows to turn the board on/off by pushing it with a pin (please note that the switch is inactive if the board doesn't support "live insertion"). Refer to § 5.2 for the power ON procedure

3.6. Internal hardware components

The module is constituted by a motherboard with a piggy-back board plugged into it (see also Fig. 1.2 where the functional blocks hosted on the piggy-back board are pointed out). In the following some hardware setting components, located on the boards, are listed. Refer to Fig. 3.4 and Fig. 3.5 for their exact location on the PCB and their settings.

3.6.1. Switches

- ROTARY SWITCHES:** *Type:* 4 rotary switches.
Function: they allow to select the VME address of the module. Please refer to Fig. 3.4 for their settings.
- TERM ON (V775):** *Type:* 14 DIP switches, a couple (positive and negative) for each control signal.
Function: they allow the insertion of the Bus termination on the relevant line. The 110 Ω -termination must be inserted on the lines of the last board of the chain. In order to insert the termination on a given line, both the positive and the negative DIP switches must be set (refer to Fig. 3.4).
- Right position** (dot visible): the termination is inserted on the relevant line;
- Left position** (dot not visible): the termination is not inserted.

3.6.2. Jumpers

- J12:** *Function:* it allows to select board behaviour in response to a BUSY status:
- Position A** (high): data acquisition is stopped as soon as any of the boards on the CONTROL Bus is BUSY;
- Position B** (low): data acquisition is stopped as the board is BUSY, independently from the status of the other boards on the CONTROL Bus.

Refer to Fig. 3.4 for the exact location of the jumper on the PCB and its setting.

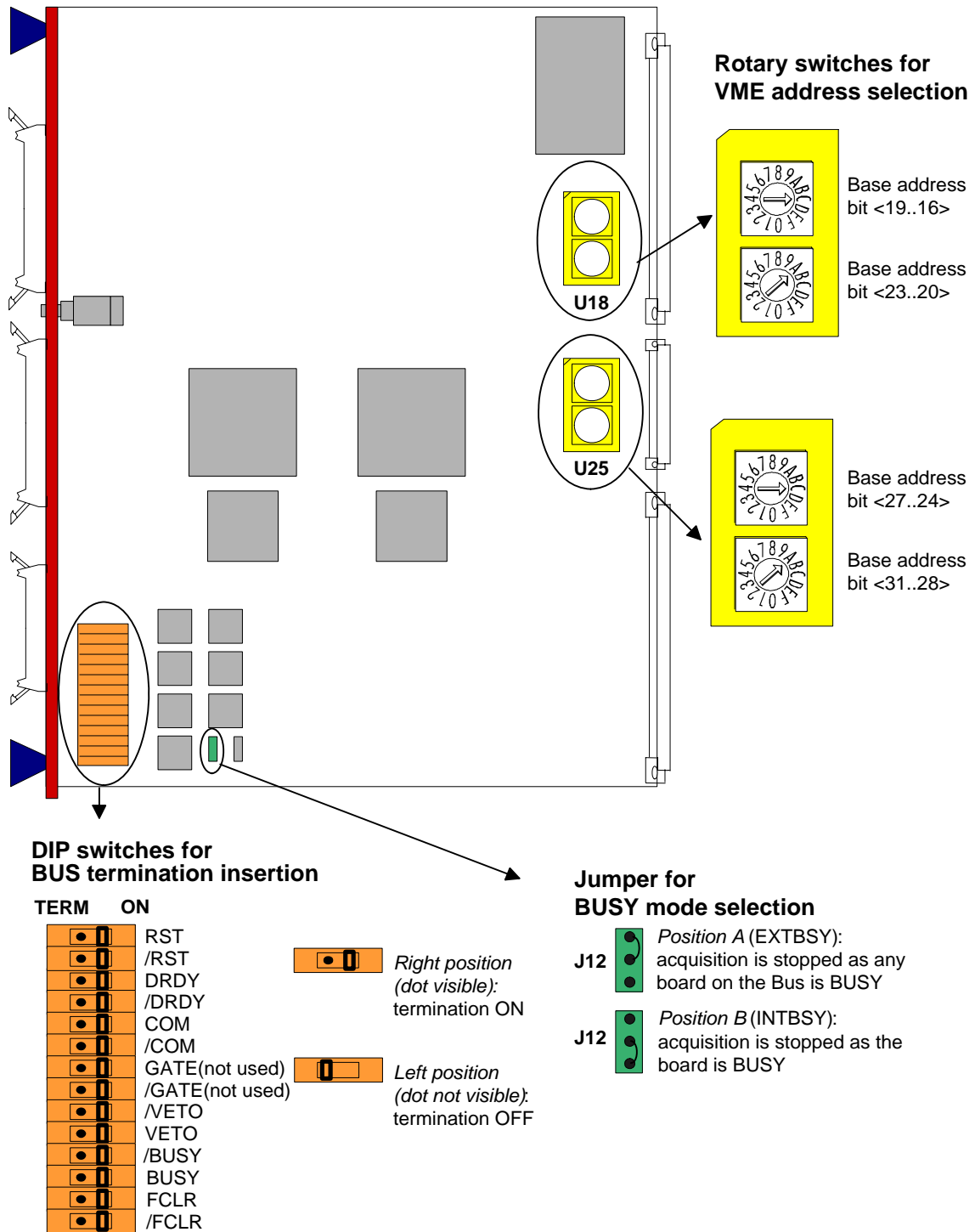

Fig. 3.4: V775 Component Location (component side)

3.6.3. Soldering pads

S9 (VEE):

Function: it allows to connect the second pin of the CONTROL connector to the VEE power supply (-5 V).

No Soldering (default): the pin 2 of the CONTROL connector is not connected.

Soldering: the pin 2 of the CONTROL connector is connected to VEE power supply (-5 V).

S10 (GND):

Function: it allows to connect the first pin of the CONTROL connector to the DIGITAL GROUND.

No Soldering (default): the pin 1 of the CONTROL connector is not connected.

Soldering: the pin 1 of the CONTROL connector is connected to the digital ground.

Refer to Fig. 3.5 for the exact location of these pads on the PCB and their settings.

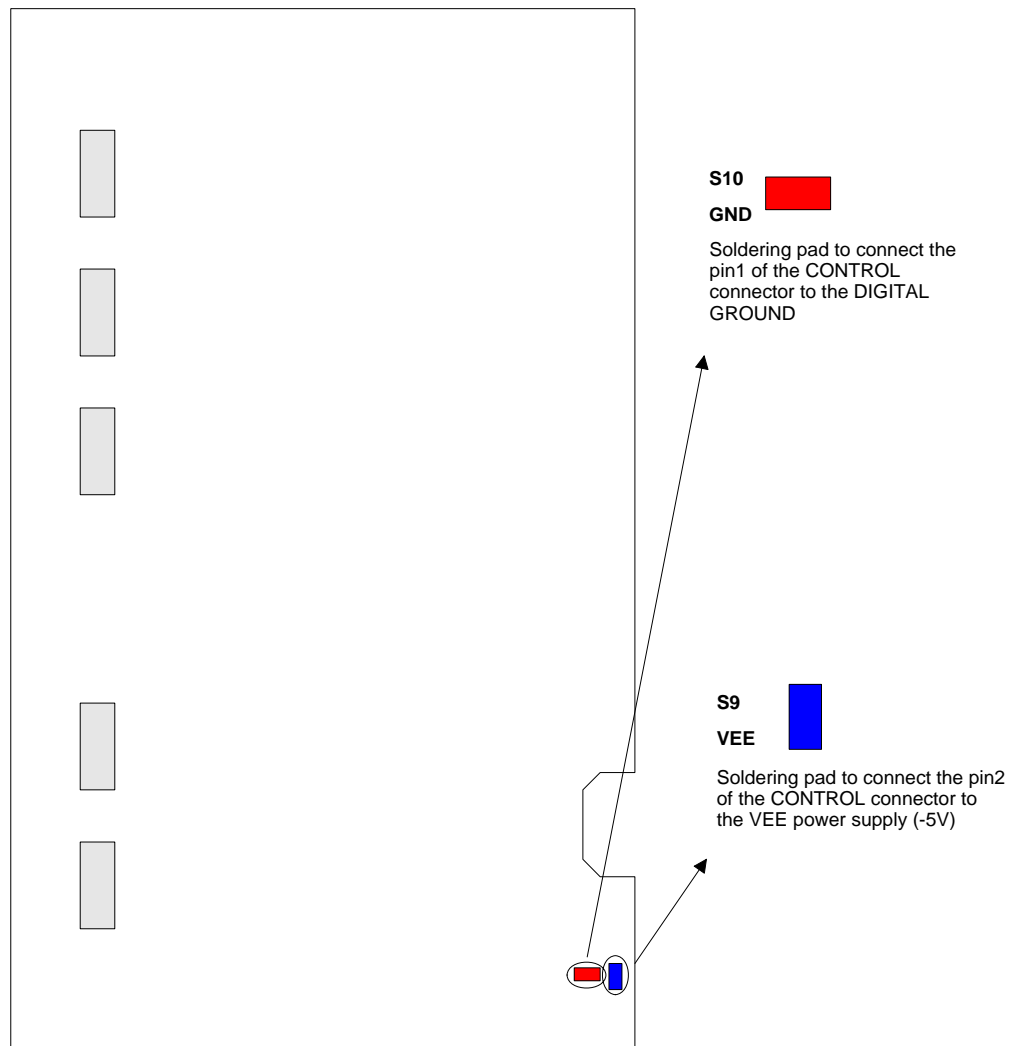

Fig. 3.5: Components location (soldering side)

3.7. Technical specifications table

Table 3.2 : Model V775 technical specifications

Packaging	6U-high, 1U-wide VME unit (version AA requires the V430 backplane)
Power requirements	Refer to Table 3.1
Inputs	V775: 32 ECL inputs, 110 Ω impedance V775 N: 16 NIM inputs, 50 Ω impedance
Full Scale Range	VME programmable from 140 to 1200 ns ¹
LSB	VME programmable from 35 to 300 ps
RMS noise	0.8 counts typical, 2 counts maximum
Integral non linearity	$\pm 0.1\%$ of FSR ²
Differential non linearity	$\pm 1\%$ ²
Interchannel isolation	> 66 dB
Power rejection	0.01 count/mV (+5V); 0.02 count/mV (-5V) 0.005 count/mV (+12V); 0.001 count/mV (-12V)
Fast clear time	600 ns
Conversion time	V775: 5.7 μ s; V775 N: 2.8 μ s
Minimum Start/Stop delay	Common Start mode: 14 ns Common Stop mode: 4 ns
Zero suppression	Threshold values programmable in: 16 ADC counts steps over the entire FSR 2 ADC counts steps over 1/8 of FSR
GATE COMMON input	Two LEMO 00 bridged connectors, NIM signal, high impedance Common Start/Stop signal
Control inputs	V775: active-high, differential ECL; V775 N: standard NIM logic: RST: resets PEAK sections, MEB status and control registers. VETO: inhibits the conversion of the peaks. FCLR: FAST CLEAR of TAC sections COM: Common Start/Stop signal
Control outputs	V775: active-high, differential ECL; V775 N: standard NIM logic: DRDY: indicates the presence of data BUSY: board full, resetting, converting or in MEMORY TEST mode
VME interface	A24/A32 Geographical addressing Multicast commands D16/D32, BLT32/MBLT64, CBLT32/CBLT64

¹ if sliding scale is enabled FSR is reduced from 4095 to 3840 counts

² measured from 5% to 95% of FSR = 3840 counts

4. VME interface

4.1. Addressing capability

The modules can be addressed in three different ways, specifically:

1. via Base Address;
2. via GEOgraphical address;
3. via Multicast/Chained Block Transfer addressing mode.

4.1.1. Addressing via Base Address

The module works in A24/A32 mode. This implies that the module's address must be specified in a word of 24 or 32 bit. The Address Modifier codes recognised by the module are summarised in Table 4.1.

Table 4.1: Module recognised Address Modifier

A.M.	Description
0x3F	A24 supervisory block transfer (BLT)
0x3D	A24 supervisory data access
0x3C	A24 supervisory 64 bit block transfer (MBLT)
0x3B	A24 non privileged block transfer (BLT)
0x39	A24 non privileged User data access
0x38	A24 non privileged 64 bit block transfer (MBLT)
0x2F	Configuration Rom/Control & Status Register (CR/CSR)
0x0F	A32 supervisory block transfer (BLT)
0x0D	A32 supervisory data access
0x0C	A32 supervisory 64 bit block transfer (MBLT)
0x0B	A32 non privileged block transfer (BLT)
0x09	A32 non privileged data access
0x08	A32 non privileged 64 bit block transfer (MBLT)

The Base Address can be selected in the range:

0x000000	↔	0xFF0000	A24 mode
0x00000000	↔	0xFFFF0000	A32 mode

The Base Address of the module can be fixed in two ways:

- by four rotary switches;
- by writing the Base Address in the ADER_HIGH and ADER_LOW registers.

The 4 rotary switches for Base Address selection are housed on two piggy-back boards plugged into the main printed circuit board (see Fig. 3.4).

To use this addressing mode the bit 4 of the Bit Set 1 Register (see § 4.8) must be set to 0. This is also the default setting.

The module Base Address can be also fixed by using the Ader_High and Ader_Low Registers. These two registers set respectively the A[31:24] and the A[23:16] VME address bits (see § 4.14 and 4.15).
 To use this addressing mode bit 4 of the Bit Set 1 Register (see § 4.8) must be set to 1.

4.1.2. Addressing via geographical address

The module works in A24 mode only. The Address Modifiers codes recognised by the module are:

AM=0x2F: A24 GEO access

All registers except for the Output Buffer (i.e. the CR/CSR area) can be accessed via geographical addressing.

The geographical address is automatically read out at each RESET from the SN5..SN1 lines of the PAUX connector. Each slot of the VME crate is identified by the status of the SN5...SN1 lines: for example, the slot #5 will have these lines respectively at 00101 and consequently the module inserted in the slot #5 will have a GEO address set to 00101 (see Fig. 4.1).

The complete address in A24 mode for geographical addressing is:

A[31:24] don't care
A[23:19] GEO
A[18:16] 0
A[15:0] offset

The following two figures show the binary and the hexadecimal representation of, respectively, the board Address and a Register Address (Bit Set 1 Register) in GEO addressing mode.

23	22	21	20	19	18	17	16	15	14	13	12	11	10	9	8	7	6	5	4	3	2	1	0
0	0	1	0	1	0	0	0	0	0	0	0	0	0	0	0	0	0	0	0	0	0	0	0
2				8				0				0				0				0			

Binary representation
 Hexadecimal representation

Fig. 4.1: Binary-Hexadecimal representation of the board Address in GEO mode

23	22	21	20	19	18	17	16	15	14	13	12	11	10	9	8	7	6	5	4	3	2	1	0
0	0	1	0	1	0	0	0	0	0	0	1	0	0	0	0	0	0	0	0	0	1	1	0
2				8				1006(offset)															

Binary representation
 Hexadecimal representation

Fig. 4.2: Binary-Hexadecimal representation of Bit Set 1 Register Address in GEO mode

It is suggested to perform module settings in geographical addressing mode

N.B.: In the case of versions where the SN5...SN1 lines are not available (i.e. the versions without the PAUX connector), addressing via geographical address is not possible.

Although in these versions it is possible to perform a write access to the GEO Address Register (see § 4.6) for data identification during CBLT operation (see § 4.1.4), it is incorrect to use the GEO Address Register for addressing purposes when there is no PAUX.

4.1.3. Base/GEO addressing examples

The following is an example of Base/GEO Addressing for two V775 boards inserted in a VME crate.

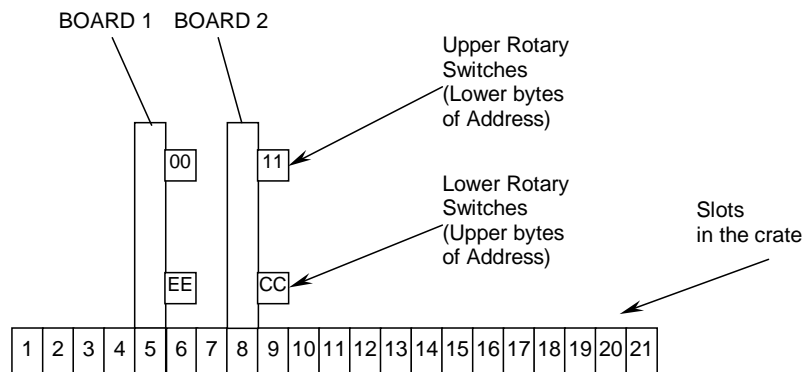

Fig. 4.3: Base/GEO Addressing: Example 1

If the board 1 and board 2 are respectively inserted in the slots 5 and 8 with the rotary switches for VME Base Addressing set as shown in the figure, the complete address of the registers of the two boards will be as follows:

Board 1:

Base addressing A32: 0xEE000000 + offset
 Base addressing A24: 0x000000 + offset
 GEO addressing A24: 0x280000 + offset (Output Buffer excluded).

Board 2:

Base addressing A32: 0xCC110000 + offset
 Base addressing A24: 0x110000 + offset
 GEO addressing A24: 0x400000 + offset (Output Buffer excluded).

4.1.4. MCST/CBLT addressing

When the Multicast/Chained Block Transfer addressing mode is adopted, the module works in A32 mode only. The Address Modifiers codes recognised by the module are:

- AM=0x0F: A32 supervisory block transfer (CBLT)
- AM=0x0D: A32 supervisory data access (MCST)
- AM=0x0B: A32 User block transfer (CBLT)
- AM=0x09: A32 User data access (MCST)

The boards can be accessed in Multicast Commands mode (MCST mode, see [4]), that allows to write in the registers of several boards at the same time by accessing the MCST Base Address in A32 only once.

The boards can be accessed in Chained Block Transfer mode (CBLT mode, see [4]) that allows to readout sequentially a certain number of contiguous boards in a VME crate. This access is allowed in BLT32 and BLT64 modes only to the MCST Base Address.

N.B.: The Base Address used for MCST and CBLT operations is the same, i.e. throughout this User's Manual the "MCST Base Address" identifies the same Address, used both for MCST commands (in Write only) and the CBLT Readout (in Read only, for the Output Buffer only).

The MCST Base Address must be set in a different way from the ordinary Base Address. Its most significant byte (i.e. bits 31 through 24) must be written in the MCST/CBLT Address Register (see § 4.7) and must be set in common to all boards belonging to the MCST/CBLT chain (i.e. all boards must have the same setting of the MCST/CBLT Base Address on bits 31 through 24). The default setting is 0xAA.

In CBLT/ MCST operations, the IACKIN/ IACKOUT daisy chain is used to pass a token from one board to the following one. The board which has received the token stores/sends the data from/to the master via CBLT/ MCST access. No empty slots must thus be left between the boards or, in alternative, empty slots can be left only in case VME crates with automatic IACKIN/IACKOUT short-circuiting are used.

Once the addresses have been set, the first and last board in a chain must have, respectively, only the FIRST_BOARD (F_B) and only the LAST_BOARD (L_B) bit set to 1 in the MCST Control Register (see § 4.17). On the contrary, all intermediate boards must have both the FIRST_BOARD and the LAST_BOARD bits set to 1 (active, intermediate) or both the FIRST_BOARD and the LAST_BOARD bits set to 0 (inactive). By default these bits are set to 0 (the board is inactive).

Board status	Board position in the chain	F_B bit	L_B bit
inactive	-	0	0
active	last	0	1
active	first	1	0
active	intermediate	1	1

Please note that in a chain there must be one (and only one) *first board* (i.e. a board with F_B bit set to 1 and the L_B bit set to 0) and one (and only one) *last board* (i.e. a board with F_B bit set to 0 and the L_B bit set to 1).

The complete address in A32 mode is:

A [31:24] MCST/CBLT Address
A [23:16] 00
A [15:0] offset

In MCST/CBLT operation it is possible to define more chains in the same crate, but each chain must have an address different from the other.

N.B.: In CBLT operation the data coming from different boards are tagged with the HEADER and with the EOB words containing the GEO address in the 5 MSB (see § 4.5). In the versions without the PAUX connector it is up to the User to write the GEO address in the GEO register (this operation is allowed only if the PAUX is not

present) before executing the CBLT operation. If the GEO address is not written in the relevant register before performing the CBLT operation, it will not be possible to identify the module which the data are coming from.

4.1.5. MCST/CBLT addressing examples

The following is an example of MCST and CBLT addressing for four V775 boards plugged into a VME crate. To access the boards the steps to be performed are as follows:

1. Set the MCST address (see § 4.7) for all boards via VME Base Address or geographical addressing (if available);
2. Set the bits F_B and L_B of the MCST Control Register (see § 4.17) according to the operational status (active or inactive) of each board and to its position in the chain (first, intermediate or last);
3. Write or read the boards via MCST/CBLT addressing.

An example of User procedures which can be used to perform a write access is:

vme_write (address, data, addr_mode, data_mode),

which contain the following parameters:

Address: the complete address, i.e. Base Address + offset;
Data: the data to be either written or read;
Addr_mode: the addressing mode (A32);
Data_mode: the data mode (D16, D32 or D64).

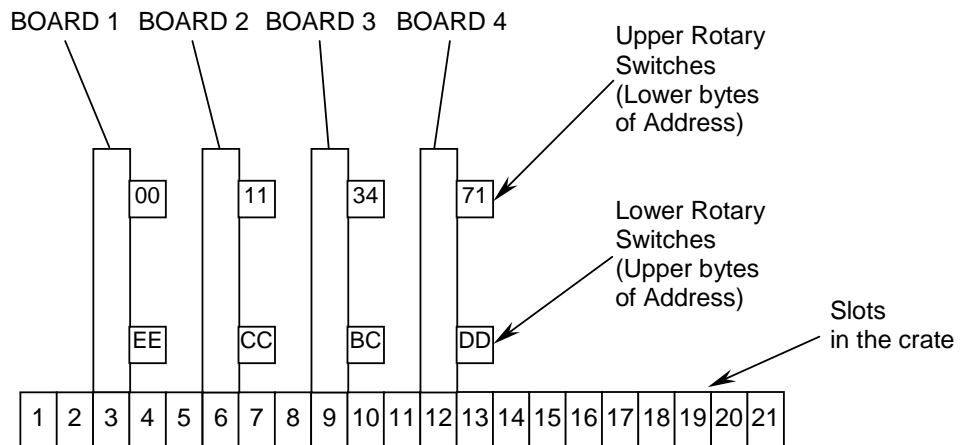

Fig. 4.4: MCST/CBLT Addressing Example

In the following two software examples using the above mentioned procedures are listed:

Example of Access via Base Address

```
vme_write (0xEE001004, 0xAA, A32, D16) /* set MCST Address=0xAA for board 1 */
vme_write (0xCC111004, 0xAA, A32, D16) /* set MCST Address=0xAA for board 2 */
vme_write (0xBC341004, 0xAA, A32, D16) /* set MCST Address=0xAA for board 3 */
vme_write (0xDD711004, 0xAA, A32, D16) /* set MCST Address=0xAA for board 4 */
vme_write (0xEE00101A, 0x02, A32, D16) /* set board 1 = First */
vme_write (0xCC11101A, 0x03, A32, D16) /* set board 2 = Active */
vme_write (0xBC34101A, 0x00, A32, D16) /* set board 3 = Inactive */
vme_write (0xDD71101A, 0x01, A32, D16) /* set board 4 = Last */
vme_write (0xAA001006, 0x80, A32, D16) /* set RESET MODE for all the boards */
```

Example of Access via geographical address

```
vme_write (0x180016, 0xAA, A24, D16) /* set MCST Address=0xAA for board 1 */
vme_write (0x300016, 0xAA, A24, D16) /* set MCST Address=0xAA for board 2 */
vme_write (0x480016, 0xAA, A24, D16) /* set MCST Address=0xAA for board 3 */
vme_write (0x510016, 0xAA, A24, D16) /* set MCST Address=0xAA for board 4 */
vme_write (0x180040, 0x02, A24, D16) /* set board 1 = First */
vme_write (0x300040, 0x03, A24, D16) /* set board 2 = Active */
vme_write (0x480040, 0x00, A24, D16) /* set board 3 = Inactive */
vme_write (0x510040, 0x01, A24, D16) /* set board 4 = Last */
vme_write (0xAA001006, 0x80, A32, D16) /* set RESET MODE for all the boards */
```

N.B.: there must be always one (and only one) FIRST BOARD and one (and only one) LAST BOARD.

4.2. Interrupter capability

The Mod. V775 houses a RORA-type VME INTERRUPTER. The INTERRUPTER responds to 8 bit, 16 bit and 32 bit Interrupt Acknowledge cycles providing an 8-bit STATUS/ID on the VME data lines D00..D07.

4.2.1. Interrupt Status/ID

The interrupt STATUS/ID is 8-bit wide, and it is contained in the 8LSB of the Interrupt Vector Register (see § 4.11). The register is available at the VME address: Base Address + 0x100C.

4.2.2. Interrupt Level

The interrupt level corresponds to the value stored in the 3LSB of the Interrupt Level Register (see § 4.10). The register is available at the VME address: Base Address + 0x100A. If the 3LSB of this register are set to 0, the Interrupt generation is disabled.

4.2.3. Interrupt Generation

An Interrupt is generated when the number of events stored in the memory equals the value written in the Event Trigger Register at the VME address: Base Address + 0x1020 (see § 4.18). If the value in Event Trigger Register is set to 0 the interrupt is disabled (default setting).

4.2.4. Interrupt Request Release

The INTERRUPTER removes its Interrupt request when a Read Access is performed to the Output Buffer so that the number of events stored in the memory decreases and becomes less than the value written in the Event Trigger Register.

4.3. Data transfer capability

The internal registers are accessible in D16 mode, unless otherwise specified. Access in D32, BLT32, MBLT64, CBLT32 and CBLT64 is available for the data buffer.

4.4. Register address map

The Address map for the Model V775 is listed in Table 4.2. All register addresses are referred to the Base Address of the board, i.e. the addresses reported in the Tables are the offsets to be added to the board Base Address.

The Table gives also information about the effects of RESET on the registers. In particular, column 2 through 4 refer to the following RESET operations:

- **D R → Data RESET;**
- **S R → Software RESET;**
- **H R → Hardware RESET.**

If a register has a mark in these columns, it means that the relevant RESET operation resets that register. For further details on the RESET Logic please refer to § 2.10.

Table 4.3 and Table 4.4 list register addresses (offset) in CBLT and MCST operations, respectively.

The ROM address map is reported in

Table 4.5, p.63.

Table 4.2: Address Map for the Model V775

Register content	DR	SR	HR	Address	Type	Access mode
Output Buffer	✓	✓	✓	0x0000÷0x0FFC	Read only	D32/D64
Firmware Revision				0x1000	Read only	D16
Geo Address				0x1002	Read/Write (**)	D16
MCST/CBLT Address			✓	0x1004	Read/Write	D16
Bit Set 1		✓ (*)	✓ (*)	0x1006	Read/Write	D16
Bit Clear 1		✓ (*)	✓ (*)	0x1008	Read/Write	D16
Interrupt Level		✓	✓	0x100A	Read/Write	D16
Interrupt Vector		✓	✓	0x100C	Read/Write	D16
Status Register 1		✓	✓	0x100E	Read only	D16
Control Register 1		✓ (*)	✓ (*)	0x1010	Read/Write	D16
ADER High			✓	0x1012	Read/Write	D16
ADER Low			✓	0x1014	Read/Write	D16
Single Shot Reset				0x1016	Write only	D16
MCST/CBLT Ctrl			✓	0x101A	Read/Write	D16
Event Trigger Register		✓	✓	0x1020	Read/Write	D16
Status Register 2		✓	✓	0x1022	Read only	D16
Event Counter_L	✓ (*)	✓ (*)	✓ (*)	0x1024	Read only	D16
Event Counter_H	✓ (*)	✓ (*)	✓ (*)	0x1026	Read only	D16
Increment Event				0x1028	Write only	D16
Increment Offset				0x102A	Write only	D16
Load Test Register				0x102C	Read/Write	D16
FCLR Window		✓	✓	0x102E	Read/Write	D16
Bit Set 2		✓	✓	0x1032	Read/Write	D16
Bit Clear 2		✓	✓	0x1034	Write only	D16
W Memory Test Address		✓	✓	0x1036	Write only	D16
Memory Test Word_High		✓	✓	0x1038	Write only	D16
Memory Test Word_Low				0x103A	Write only	D16
Crate Select		✓	✓	0x103C	Read/Write	D16
Test Event Write				0x103E	Write only	D16
Event Counter Reset				0x1040	Write only	D16
Full Scale Range		✓	✓	0x1060	Read/Write	D16
R Test Address		✓	✓	0x1064	Write only	D16
SW Comm				0x1068	Write only	D16
Slide Constant				0x106A	Read/Write	D16
AAD				0x1070	Read only	D16
BAD				0x1072	Read only	D16
Thresholds				0x1080÷ 0x10BE	Read/Write	D16

(*) not all bits are reset with the same type of RESET: see the description of the relevant register for details.

(**) Write access is allowed only in AMNESIA cases (see § 4.12), i.e. when there is no PAUX.

The ROM address map is from 0x8000 to 0xFFFF: refer to § 4.40.

Table 4.3: Address Map in CBLT operation

Register content	Address	Type	Access mode
Output Buffer	0x0000÷0x07FF	Read only	D32/D64

Table 4.4: Address Map in MCST operations

Register content	Address	Type	Access mode
Bit Set 1	0x1006	Write only	D16
Bit Clear 1	0x1008	Write only	D16
Interrupt Level	0x100A	Write only	D16
Interrupt Vector	0x100C	Write only	D16
Control Register 1	0x1010	Write only	D16
ADER High	0x1012	Write only	D16
ADER Low	0x1014	Write only	D16
Single Shot Reset	0x1016	Write only	D16
Event Trigger Register	0x1020	Write only	D16
Increment Event	0x1028	Write only	D16
Increment Offset	0x102A	Write only	D16
Load Test Register	0x102C	Write only	D16
Fast Clear Window	0x102E	Write only	D16
Bit Set 2	0x1032	Write only	D16
Bit Clear 2	0x1034	Write only	D16
W Memory Test Address	0x1036	Write only	D16
Memory Test Word_High	0x1038	Write only	D16
Memory Test Word_Low	0x103A	Write only	D16
Crate Select	0x103C	Write only	D16
Event Counter Reset	0x1040	Write only	D16
Full Scale Range	0x1060	Write only	D16
R Test Address	0x1064	Write only	D16
SW comm	0x1068	Write only	D16
Thresholds	0x1080 ÷ 0x10BF	Write only	D16

4.5. Output Buffer

(Base Address + 0x0000 ÷ 0x0FFC, read only)

This register allows the User to access the Multiple Event Buffer to readout the converted values.

The output buffer contains the output data organised in 32-bit words.

The data in the buffer are organised in events.
 Each event consists of:

- the **header**, that contains the geographical address, the crate number and the number of converted channels;
- one or more **data words**, each of which contains the geographical address, the number of the channel, the Valid (V) bit, the Under-Threshold (UN) bit, the Overflow (OV) bit and the 12-bit converted value;
- the **End Of Block (EOB)**, which contains the geographical address and the event counter.

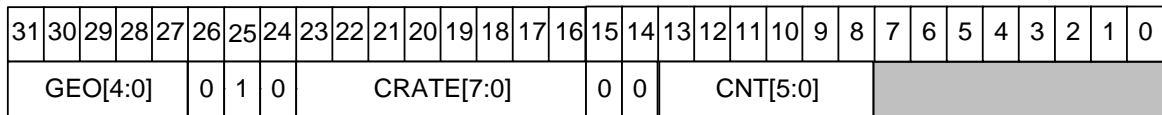
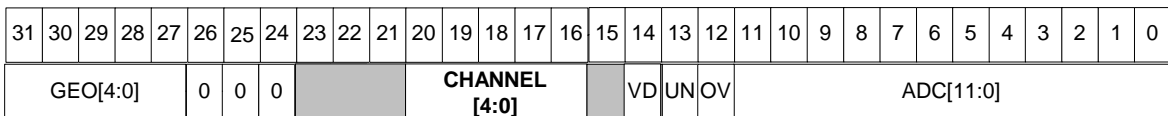

Fig. 4.5: Output buffer: the Header

V775:



V775N:

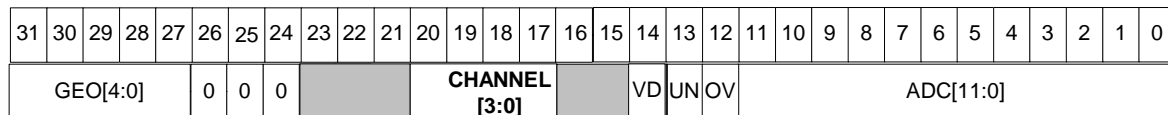

Fig. 4.6: Output buffer: the data word format

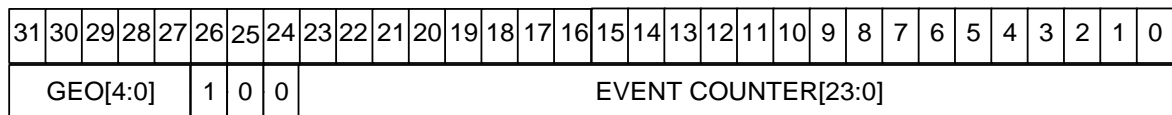

Fig. 4.7: Output buffer: the End Of Block

Header content:

The bits[31...27] contains the GEO address.

The bits[26..24] identify the type of word (010 → header);

The bits[23..16] identify the crate number according to the content of the Crate Select Register (see § 4.30).

The bits[13...8] contain the number of memorised channels.

Datum content:

The bits[31...27] contains the GEO address.

The bits[26..24] identify the type of word (000 → datum);

The bits[20..16] (bits[20..17] in the V775 N) identify the number of the channel which the data are coming from.

The bit[14] is the VALID bit:

= 1 → the datum is valid;

= 0 → the datum is not valid; it is actually possible to make the datum be written in the buffer even if it is not valid by using the bit 5 of the Bit Set 2 Register (see § 4.26);

The bit[13] is the UNDERTHRESHOLD bit (see § 2.4):

= 0 → the datum is over the threshold fixed in the relevant register;

= 1 → the datum is under the threshold fixed in the relevant register; it is actually possible to make the datum be written in the buffer even if it is under the threshold by using the bit 4 of the Bit Set 2 Register (see § 4.26));

The bit[12] is the OVERFLOW bit (see § 2.5):

= 0 → ADC not in overflow condition;

= 1 → ADC in overflow; it is actually possible to make the datum be written in the buffer even if it is out of range by using the bit 3 of the Bit Set 2 Register (see § 4.26));

The bits[11...0] contain the converted datum.

EOB content:

The bits[31...27] contains the GEO address.

The bits[26..24] identify the type of word (100 → EOB);

The bits[23..0] contain the 24-bit event counter value (see § 4.20).

The bits[31...27] always contains the GEO address (except for the not valid datum, see Fig. 4.8).

The bits[26..24] identify the type of word, according to the following:

- 010 → header;
- 000 → valid datum;
- 100 → end of block;
- 110 → not valid datum.
- *others* → reserved.

If a read access is performed to the buffer when it is empty, the readout will provide a NOT VALID DATUM arranged as shown in Fig. 4.8.

31	30	29	28	27	26	25	24	23	22	21	20	19	18	17	16	15	14	13	12	11	10	9	8	7	6	5	4	3	2	1	0					
					1	1	0																													

Fig. 4.8: Output buffer: not valid datum

The sequence followed to store the data in the buffer is as follows:

V775:	V775N:
CHANNEL 0	CHANNEL 0
CHANNEL 16	CHANNEL 8
CHANNEL 1	CHANNEL 1
CHANNEL 17	CHANNEL 9
CHANNEL 2	CHANNEL 2
.....
CHANNEL 15	CHANNEL 7
CHANNEL 31	CHANNEL 15

Please note that some of the above channel data may be missing in the sequence: this is due either to overflow or under threshold conditions (which caused these data not to be stored), or to User's settings to kill some channels. Fig. 4.9 shows an example of the Multi-Event Buffer structure in case of zero suppression enabled and with event counter set so as to count all events (see § 2.8). The first event written in the active Event Buffer (Write pointer = n) is that relative to the GATE n.5 during which two channels (2 and 5) were over the programmed threshold: the stored event is constituted by a Header, the data relative to the two channels and the End of Block word at the end of all converted data of the relevant Event. During GATE n.6 and n. 7 no channels were in the selected range. The next event written in the following active Event Buffer (Write pointer = n+1) is that relative to the GATE n.8: it consists of the Header, the data relative to three channels (0, 17 and 3) and the End of Block word at the end of all converted data.

	31	30	29	28	27	26	25	24	23	22	21	20	19	18	17	16	15	14	13	12	11	10	9	8	7	6	5	4	3	2	1	0
Write Pointer N GATE 5	GEO					0	1	0	CRATE NUMBER								0	0	MEM. CHANNELS (2)													
	GEO					0	0	0					CHANNEL (2)								UN	OV	ADC COUNTS									
	GEO					0	0	0					CHANNEL (5)								UN	OV	ADC COUNTS									
	GEO					1	0	0	EVENT COUNTER (m)																							
Write Pointer N+1 GATE 8	GEO					0	1	0	CRATE NUMBER								0	0	MEM. CHANNELS (3)													
	GEO					0	0	0					CHANNEL (0)								UN	OV	ADC COUNTS									
	GEO					0	0	0					CHANNEL (17)								UN	OV	ADC COUNTS									
	GEO					0	0	0					CHANNEL (3)								UN	OV	ADC COUNTS									
GEO					1	0	0	EVENT COUNTER (m+3)																								

Fig. 4.9: Multi-Event Buffer: data structure example

N.B.: in the versions which do not have the PAUX connector, the GEO address must be written by the User via a write access to the relevant register (see § 4.6). If this operation is not performed, it will be not possible to identify which module the data are coming from when the CBLT access is used.

4.6. GEO Address Register

(Base Address + 0x1002, read/write; write cycles are allowed only for the versions without PAUX connector)

This register contains the geographical address of the module, i.e. the slot number picked up from the JAUX connector on the VME backplane. The register is filled up upon arrival of a RESET. The register content is the following:

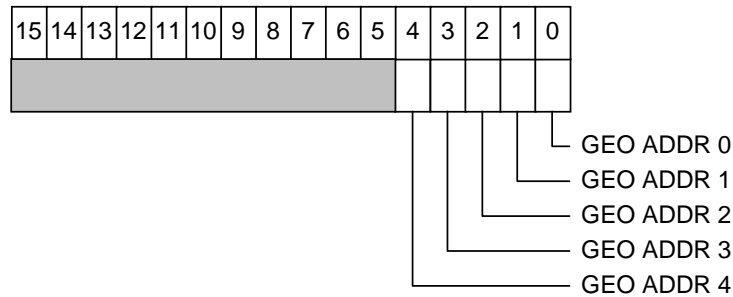

Fig. 4.10: Geographical address register

GEO [4...0] corresponds to A23...A19 in the address space of the CR/CSR area: each slot has a relevant number whose binary encoding consists of the GEO ADDR 4 to 0.

In the versions without the PAUX connector this register can be also written (see also AMNESIA bit in the Status Register 1; refer to § 4.12). The bits of the GEO Address register are set to 1 by default. In CBLT operation it is up to the User to write the correct GEO address of the module in this register before operating so that the GEO address will be contained in the HEADER and the EOB words for data identification.

If a write access to the GEO register is performed in the versions with the PAUX connector, the module does not respond and the bus will go in timeout.

N.B.: In the case of versions where the SN5...SN1 lines are not available (i.e. the versions without the PAUX connector), addressing via geographical address is not available.

Although in these versions it is possible to perform a write access to the GEO Address Register for data identification during CBLT operation (see § 4.1.4), avoid to use the GEO Address Register for addressing purposes when there is no PAUX.

N.B.: after a write access to the GEO Address register, it is necessary to perform a reset to make the change active.

4.7. MCST/CBLT Address Register

(Base Address + 0x1004, read/write)

This register contains the most significant bits of the MCST/CBLT address of the module set via VME, i.e. the address used in MCST/CBLT operations. Refer to § 4.1.4 for details about MCST/CBLT addressing mode.

The register content is the following:

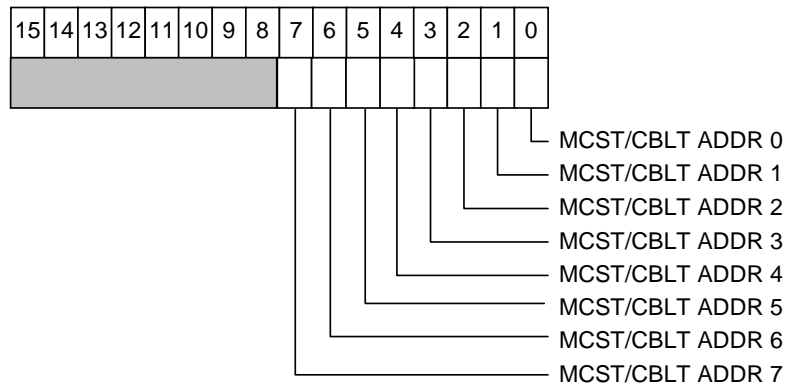

Fig. 4.11: MCST/CBLT address register

Default setting (i.e. at power ON or after hardware reset) is 0xAA.

4.8. Bit Set 1 Register

(Base Address + 0x1006, read/write)

This register allows to set the RESET logic of the module and to enable the change of the base address via VME.

A write access with the bits to 1 sets the relevant bits to 1 in the register (i.e. writing 0x10 to this register sets the SEL ADDR bit to 1). A write access with the bits set to 0 does NOT clear the register content; in other words, when 1 is written into one particular bit, such bit is set to 1, if 0 is written, the bit remains unchanged. In order to clear the register content, the Bit Clear 1 Register must be used (see § 4.9).

A read access returns the status of this register.

The register content is the following:

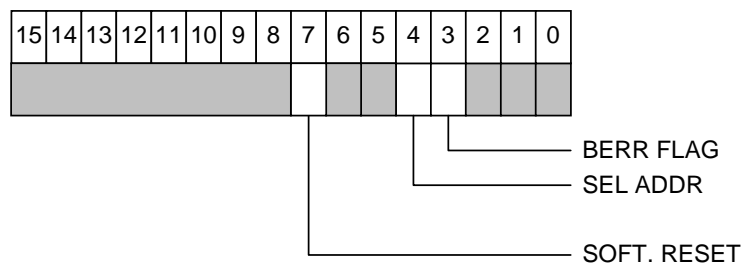

Fig. 4.12: Bit Set 1 Register

BERR FLAG:

Bus Error Flag Bit (meaningful in BLT/CBLT modes only). The User may set this flag for test purposes only. Its content is cleared both via an hardware and via a software reset.

- = 0 board has not generated a Bus Error (default);
- = 1 board has generated a Bus Error.

SELECT ADDRESS: Select Address bit.
 = 0 base address is selected via Rotary Switch (default);
 = 1 base address is selected via internal ADER registers.

SOFTW. RESET: Sets the module to a permanent RESET status. The RESET is released only via write access with the relevant bit set to 1 in the Bit Clear Register, see § 4.9.

This register is reset via a hardware reset (see § 2.10). Only the bit 3 (BERR FLAG) is reset both via hardware reset and software reset.

4.9. Bit Clear 1 Register

(Base Address + 0x1008, read/write)

This register allows to clear the bits in the above described Bit Set 1 Register. A write access with a bit set to 1 resets that bit, e.g. writing 0x8 to this register resets the BERR FLAG bit. A write access with the bits set to 0 does NOT clear the register content; in other words, when 1 is written into one particular bit, such bit is set to 0 (cleared), if 0 is written, the bit remains unchanged. The structure of the register is identical to the Bit Set 1 Register. A read access returns the status of the register.

4.10. Interrupt Level Register

(Base Address + 0x100A, read/write)

The 3 LSB of this register contain the value of the interrupt level (Bits 3 to 15 are meaningless). Default setting is 0x0. In this case interrupt generation is disabled.

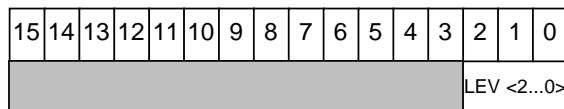

Fig. 4.13: Interrupt Level Register

4.11. Interrupt Vector Register

(Base Address + 0x100C, read/write)

This register contains the STATUS/ID that the V775 INTERRUPTER places on the VME data bus during the Interrupt Acknowledge cycle (Bits 8 to 15 are meaningless). Default setting is 0x00.

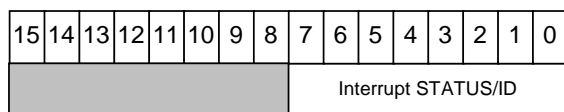

Fig. 4.14: Interrupt Vector Register

4.12. Status Register 1

(Base + 0x100E, read only)

This register contains information on the status of the module.
 TERM ON and TERM OFF refer to the terminations of the CONTROL bus lines: the last module in a chain controlled via the front panel CONTROL connector must have these terminations ON, while all the others must have them OFF. The insertion or removal of the terminations is performed via internal DIP switches (see Fig. 3.4).
 The BUSY and DATA READY signals are available both for the individually addressed module and as a global readout of a system of many units connected together via the CONTROL bus.

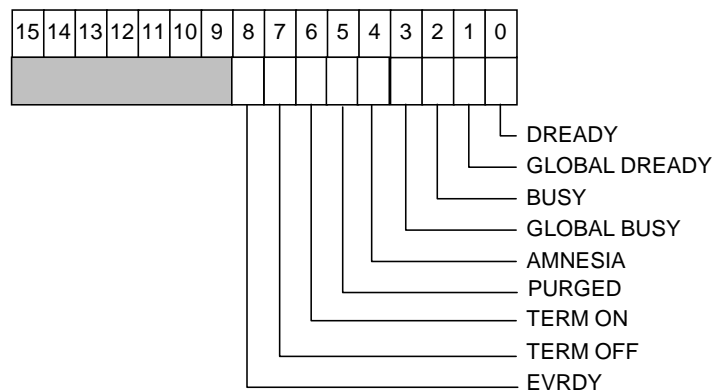

Fig. 4.15: Status Register 1

- DREADY:** Indicates that there are data (at least 1 event) in the Output Buffer.
 = 0 No Data Ready;
 = 1 Data Ready.
- GLOBAL DREADY:** Indicates that at least one module in the chain has data in the Output Buffer (OR of the READY+ signal of each module in the chain).
 = 0 No module has Data Ready;
 = 1 At least one module has Data Ready.
- BUSY:** Busy status indicates that either a conversion is in progress or the board is resetting or the Output Buffer is full or the board is in MEMORY TEST mode.
 = 0 Module not Busy;
 = 1 Module Busy.
- GLOBAL BUSY:** Indicates that at least a module in a chain is BUSY (OR of the BUSY+ signal of each module in the chain).
 = 0 No module is Busy;
 = 1 At least a one module is Busy.
- AMNESIA:** Indicates that no GEO address was picked from the VME connectors.
 = 0 GEO is picked from the JAUX;

- = 1 GEO is not available from the JAUX: it can be written in the GEO Address Register (see § 4.6) for MCST operation.
- PURGED:** during a CBLT operation it indicates that the board is purged, i.e. the board has finished to send data.
 - = 0 the board is not purged;
 - = 1 the board is purged.
- TERM ON:** Termination ON bit.
 - = 0 not all Control Bus Terminations are ON.
 - = 1 all Control Bus Terminations are ON.
- TERM OFF:** Termination OFF bit.
 - = 0 not all Control Bus Terminations are OFF
 - = 1 all Control Bus Terminations are OFF.
- EVRDY:** is a flag for the Event Trigger Register.
 - = 0 (default) indicates that the number in the Event Trigger Register (see § 4.18) is smaller than the number of events stored in the memory;
 - = 1 indicates that the number in the Event Trigger Register (see § 4.18) is greater than or equal to the number of events stored in the memory and an interrupt request has been generated with interrupt level different from 0 (see § 4.2.3).

N.B.: the condition in which both **TERM ON** and **TERM OFF** bits are equal to 0 indicates an uncommon termination status, e.g. some terminations are on and other are off.

4.13. Control Register 1

(Base Address + 01010, read/write)

This register allows performing some module's general settings.

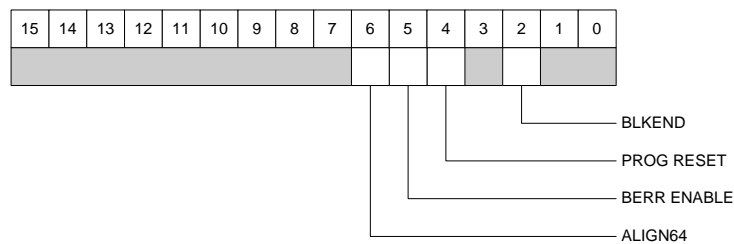

Fig. 4.16: Control Register 1

- BLKEND:** End of Block bit. Used in Block Transfer modes only.
 - = 0 The module sends all requested data to the CPU; when the Output Buffer is empty it will send no valid data. If BERR_VME is enabled (see bit 5 below, BERR ENABLE), a Bus Error is generated with the readout of the last word in the Output Buffer (default).
 - = 1 The module sends all data to the CPU until the first EOB word (end of first event) is reached; afterwards it will send no valid data. If

BERR_VME is enabled, a Bus Error is generated at the readout of the EOB word.

PROG RESET: Programmable Reset Mode setting bit.
 = 0 the front panel RESET acts only on data (data reset, default);
 = 1 the front panel RESET acts on the module (software reset).
N.B. This bit is cleared only via hardware reset.

BERR ENABLE: Bus Error enable bit. Used in Block Transfer mode only.
 = 0 the module sends a DTACK signal until the CPU inquires the module (default);
 = 1 the module is enabled to generate a Bus error to finish a block transfer.

ALIGN 64: Allows to add a 32 bit dummy-word (marked as not valid datum, see § 4.5) to an event which is made up of an odd number of words during BLT32 and CBLT32 data readout. In fact some 64 bit CPU's cut off the last 32 bit word of a transferred block if the number of words composing such block is odd, so it is necessary to add a dummy word (which will be then eventually removed via software) in order to avoid data loss. It is used in BLT32 and CBLT32 and is available in Firmware Rev. 6.02 and later.
 = 0 no dummy word added (default);
 = 1 dummy word added when the number of words is odd.

(Bits 7 to 15 are meaningless).

4.14. Address Decoder High Register

(Base Address + 0x1012, read/write)

This register contains the A31...A24 bits of the address of the module: it can be set via VME for a relocation of the Base Address of the module. The register content is the following:

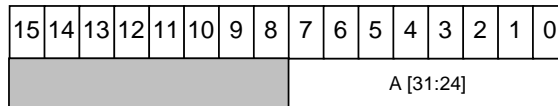

Fig. 4.17: ADER HIGH Register

4.15. Address Decoder Low Register

(Base Address + 0x1014 read/write)

This register contains the A23...A16 bits of the address of the module: it can be set via VME for a relocation of the Base Address of the module. The register content is the following:

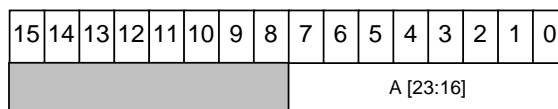

Fig. 4.18: ADER LOW Register

4.16. Single Shot Reset Register

(Base Address + 0x1016, write only)

A write access to this dummy register performs a module reset. This register must be used very carefully and for debugging purposes only. In order to reset the board, it is recommended to use the Bit Set 1 Register (see § 4.8).

4.17. MCST/CBLT Control Register

(Base Address + 0x101A, read/write)

This register allows performing some general MCST/CBLT settings of the module.

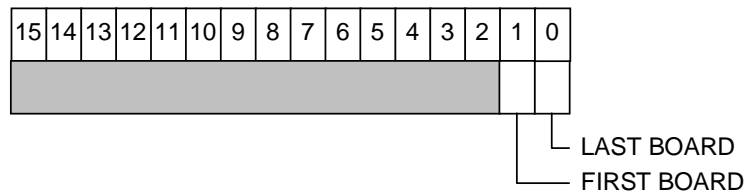

Fig. 4.19: MCST Address Register

LAST_BOARD Last Board flag bit (valid in CBLT and MCST modes only)

FIRST_BOARD First Board flag bit (valid in CBLT and MCST modes only)

The status of the boards according to the bit value is the following:

BOARD STATUS	FIRST BOARD bit	LAST BOARD bit
Board disabled in CBLT or MCST chain	0	0
First board in CBLT or MCST chain	1	0
Last board in CBLT or MCST chain	0	1
Active intermediate board in CBLT or MCST chain	1	1

(Bits 2 to 15 are meaningless).

4.18. Event Trigger Register

(Base Address + 0x1020, read/write)

This register contains a 5-bit value set by the user: when the number of events stored in the memory equals this value an interrupt request is generated.
 Default setting is 0: in this case the interrupt generation is disabled. See also § 4.2.

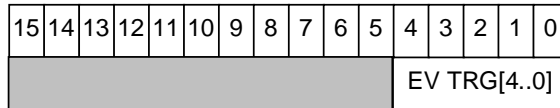

Fig. 4.20: Event Trigger Register

4.19. Status Register 2

(Base Address + 0x1022, read only)

This register contains further information on the status of the module output buffer and on the type of piggy back plugged into the main board.

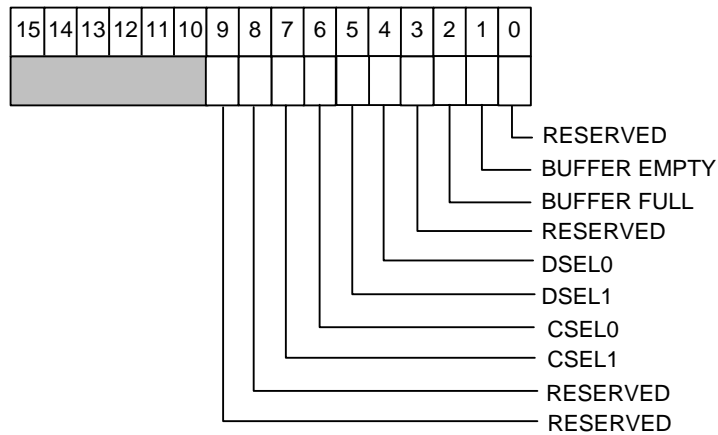

Fig. 4.21: Status Register 2

- BUFFER EMPTY:** Indicates if the output buffer is empty.
 =0 buffer not empty;
 =1 buffer empty.
- BUFFER FULL:** Indicates if the output buffer is full.
 =0 buffer not full;
 =1 buffer full.
- CSEL1, CSEL0, DSEL1, DSEL0:** Indicate the type of piggy-back plugged into the board. In the case of V 775 is 0000.

4.20. Event Counter_Low Register

(Base Address + 0x1024, read only)

It contains the 16 LSBs of the event counter. The event counter can work in two different ways (see also § 2.8):

1. it counts all events;
2. it counts only the accepted events.

The two modes can be selected via the Bit 14 (ALL TRG) of the Bit Set 2 Register (see § 4.25).

EVENT CNT LOW: 16 LSB of the 24-bit Event Counter.

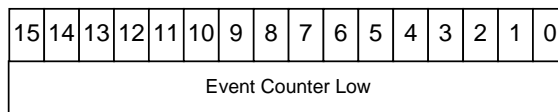

Fig. 4.22: Event Counter Low Register

This register is reset via the Event Counter Reset Register (see § 4.32) or via a software or hardware reset (see § 2.10). However, if the event counter is set so as to work as relative counter (i.e. it counts only the accepted events), this register is reset also with a data reset (see § 2.10).

4.21. Event Counter_High Register

(Base + 0x1026, read only)

It contains the 8 MSB of the 24-bit event counter. The event counter can work in two different ways (see also § 2.8):

1. it counts all events;
2. it counts only the accepted events.

The two modes can be selected via the Bit 14 (ALL TRG) of the Bit Set 2 Register (see § 4.25).

EVENT CNT HIGH: 8 MSB of the 24-bit Event Counter.

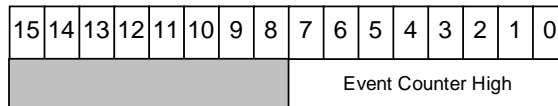

Fig. 4.23: Event Counter High Register

This register is reset via the Event Counter Reset Register (see § 4.32) or via a software or hardware reset (see § 2.10). However, if the event counter is set so as to work as

relative counter (i.e. it counts only the accepted events), this register is reset also with a data reset (see § 2.10).

4.22. Increment Event Register

(Base Address + 0x1028, write only)

A write access to this dummy register sets the readout pointer on the next event in the output buffer (at the first address).

In particular, if the bit 11 (AUTO INCR) of the Bit Set 2 Register is set to 0 (see § 4.25), the readout pointer is no more automatically incremented, but it can be incremented via a write access to this register or to the Increment Offset Register (see below).

4.23. Increment Offset Register

(Base Address + 0x102A, write only)

A write access to this dummy register increments the readout pointer of one position (next word, same event if EOB is not encountered; next event if EOB is encountered).

In particular, if the bit 11 (AUTO INCR) of the Bit Set 2 Register is set to 0 (see § 4.25), the readout pointer is no more automatically incremented, but it can be incremented via a write access to this register or to the Increment Event Register (see above).

4.24. Fast Clear Window Register

(Base Address + 0x102E, read/write)

For the definition of the Fast Clear window refer to Fig. 2.8. By writing a 10 bit number N to this register, it is possible to set the Fast Clear window width T_{FC} in the range 7÷38.5 μ s (1/32 μ s steps) according to the following relation:

$$T_{FC} (\mu\text{s}) = N \times T_{\text{CLOCK}} + 7 \mu\text{s}$$

where $T_{\text{CLOCK}} = 1/32 \mu\text{s}$.

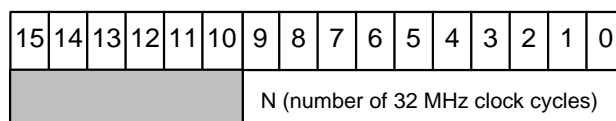

Fig. 4.24: Fast Clear Window Register

Please note that the maximum allowed value for N is 3F0 which leads to $T_{FC} = 38.5 \mu\text{s}$

4.25. Bit Set 2 Register

(Base Address + 0x1032, read/write)

This register allows to set the operation mode of the module. A write access with a bit to 1 sets the relevant bit to 1 in the register. A write access with the bit set to 0 does not clear the register content, the Bit Clear 2 Register must be used (see § 4.26). A read access returns the status of the register. The register content is the following:

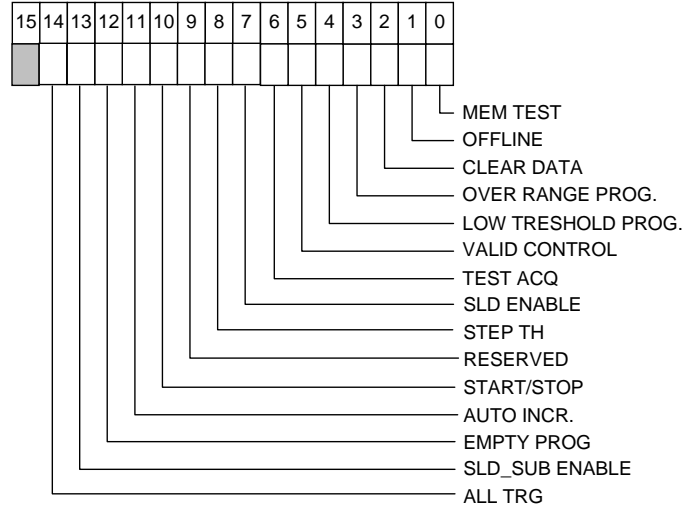

Fig. 4.26: Bit Set 2 register

N.B. DON'T MODIFY RESERVED BITS SETTINGS

- MEM TEST:** Test bit: allows to select the Random Memory Access Test Mode (see § 5.5.1).
 =0 normal mode (default);
 =1 Random Memory Access Test Mode selected: it is possible to write directly into the memory.
- OFFLINE:** Offline bit: allows to select the ADC controller's status.
 =0 ADC controller online (default);
 =1 ADC controller offline: no conversion is performed.
- CLEAR DATA:** Allows to generate a reset signal which clears the data, the write and read pointers, the event counter and the peak sections.
 =0 no data reset is generated (default);
 =1 a data reset signal is generated.
- OVER RANGE:** Allows to disable overflow suppression (see also § 2.5).
 =0 over range check enabled: only the data not causing the ADC overflow are written into the output buffer (overflow suppression; default);
 =1 over range check disabled: all the data are written into the output buffer (no overflow suppression).
- LOW THRESHOLD:** Allows to disable zero suppression (see also § 2.4).

* From firmware release 5.1, this bit (STEP_TH) allows to set the zero suppression threshold resolution, see § 2.4 for further details

- =0 low threshold check enabled: only data above the threshold are written into the output buffer (zero suppression; default);
- =1 low threshold check disabled: all the data are written into the output buffer (no zero suppression).
- VALID CONTROL:** Allows to abort memorisation of not valid data when working in Common Stop mode(see § 2.6).
- =0 valid data check enabled: only valid data are written into the output buffer;
- =1 valid data check disabled: all the data are written into the output buffer.
- TEST ACQ:** Allows to select the Acquisition Test Mode (see § 5.5.2).
- =0 normal operation mode, i.e. the data to be stored in the buffer are the real data (default);
- =1 Acquisition Test Mode selected, i.e. the data to be stored in the buffer are taken from an internal FIFO (Test Event Write Register, see § 4.31).
- SLIDE ENABLE:** Allows to enable/disable the sliding scale.
- =0 the sliding scale is disabled and the DAC of the sliding scale is set with a constant value (Slide Constant, see § 4.36);
- =1 the sliding scale is enabled (default).
- STEP TH:** Allows to set the zero suppression threshold resolution (firmware release 5.1 and later, see § 2.4 for details)
- =0 $ADC\ CONVERTED\ VALUE < THRESHOLD\ VALUE \times 16$
- =1 $ADC\ CONVERTED\ VALUE < THRESHOLD\ VALUE \times 2$
- START/STOP:** Allows to select Common Start or Common Stop mode.
- =0 Common Start mode
- =1 Common Stop mode
- AUTO INCR:** Allows to enable/disable the automatic increment of the readout pointer.
- =0 the read pointer is not incremented automatically but only by a write access to the Increment Event or Increment Offset Registers (see § 4.23);
- =1 the read pointer is incremented automatically (default).
- EMPTY PROG:** Allows to choose if writing the header and EOB when there are no accepted channels.
- =0 when there are no accepted channels, nothing is written in the output buffer (default).
- =1 when there are no accepted channels, the Header and the EOB are anyway written in the output buffer.
- SLIDE_SUB ENABLE:** Allows to change operation mode for the sliding scale.
- =0 the sliding scale works normally (default);
- =1 the subtraction section of the sliding scale is disabled (test purposes only).
- ALL TRG:** Allows to choose how to increment the event counter.
- =0 event counter incremented only on accepted triggers.

=1 event counter incremented on all triggers (default).

4.26. Bit Clear 2 Register

(Base Address + 0x1034 write only)

This register allows clearing the bits of the Bit Set 2 Register (§ 4.25). A write access with a bit set to 1 resets that bit, e.g. writing 0x4 to this register resets the CLEAR DATA bit. A write access with the bits set to 0 does NOT clear the register content. The structure of the register is identical to the Bit Set 2 Register.

4.27. W Memory Test Address Register

(Base Address + 0x1036 write only)

This register contains the address of the memory on which data can be written for the memory test.

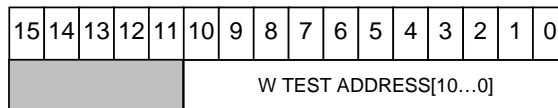

Fig. 4.27: W Memory Test Address Register

N.B.: The output buffer is a FIFO, so the read address (R Test Address Register) must be different from the write address (W Test Address Register).

4.28. Memory Test Word_High Register

(Base Address + 0x1038 write only)

The Memory Test Word is a 32-bit word used for the memory test. The higher 16 bits are set via this register, while the lower 16 bits are set via the Test Word_Low Register. These registers are used in TEST mode as follows:

1. set the module in test mode (see bit 0 of the Bit Set 2 Register, § 4.25);
2. write the memory address (see § 4.27),
3. write the 16 MSBs in the TESTWORD_HIGH register;
4. write the 16 LSBs in the TESTWORD_LOW register;

With the latter operation, the 32-bit pattern is transferred to the memory. If operations 3. and 4. are inverted, the content of the 16 MSBs may be meaningless.

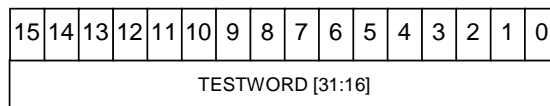

Fig. 4.28: Test Word_High Register

4.29. Memory Test Word_Low Register

(Base Address + 0x103A write only)

This register allows to set the lower 16 bits of the Memory Test Word (see above).

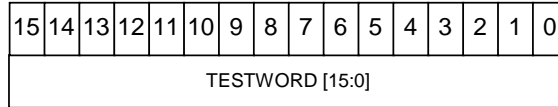

Fig. 4.29: Test Word_Low Register

4.30. Crate Select Register

(Base Address + 0x103C read/write)

This register contains the number of the crate which the board is plugged into. This register must be filled at board initialisation and will be part of the Header.

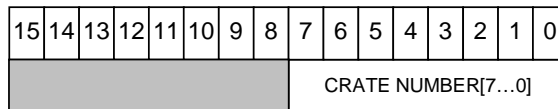

Fig. 4.30: Crate Select Register

4.31. Test Event Write Register

(Base Address + 0x103E write only)

This register is used in Acquisition Test Mode and its content constitutes the test event to be written in the output buffer.

A write access to this register allows the user to write a set of 32 data into a 32-word FIFO. As the Bit 6 (TEST ACQ) of the Bit Set 2 Register (see § 4.25) is set to 1 and the Acquisition Test Mode is consequently selected, these data are directly written in the output buffer constituting an event which can be used to test the module and/or the acquisition software.

Each 16-bit test word (see the figure below) contains a 12-bit value, acting as the ADC converted value, and an OV bit which indicates the possible overflow.

The 32 test data, corresponding to the data from the 32 channels, must be written in this FIFO in the same order as they are read from the output buffer, that is:

- test datum for the channel 0
- test datum for the channel 16
- test datum for the channel 1
-
- test datum for the channel 30
- test datum for the channel 15
- test datum for the channel 31

For further details on the use of this register in Acquisition Test Mode please refer to § 5.5.2.

N.B.: please note that the user must write at least and not more than 32 test words. Actually, since the words are written in a FIFO, if the user writes less than 32 words, some words will be not defined; on the other hand, if the user writes more than 32 words, some words will be overwritten.

15	14	13	12	11	10	9	8	7	6	5	4	3	2	1	0
				OV	TEST ADC CONVERTED VALUE[11...0]										

Fig. 4.31: Test Event Write Register

4.32. Event Counter Reset Register

(Base Address + 0x1040 write only)

A VME write access to this dummy register clears the Event Counter.

4.33. Full Scale Range register

(Base Address + 0x1060, read/write)

A write access to this register allows the User to select the Full Scale Range from 140 ns (35 ps LSB) to 1200 ns (300 ps LSB) with 8 bit resolution.

15	14	13	12	11	10	9	8	7	6	5	4	3	2	1	0
								FSR [7...0]							

Fig. 4.32: Full Scale Range Register

The 0xFF value corresponds to 35 ps LSB while the 0x1E value correspond to 300 ps LSB with a non-linear interpolation for intermediate values; the LSB is given by the formula:

$$T_{LSB} = \frac{8.9}{N} (ns)$$

The LSB is proportional to 1/N, where N is the Full Scale Range register content, because it is inversely to the current to be integrated.

For example:

If N (counts) = 0xFF, T_{LSB} is 35 ps (FSR = 0.143 μs);

If N (counts) ounts = 0x1E T_{LSB} is 297 ps (FSR = 1.21 μs);

It is recommended not to set the Full Scale Range register with values smaller than 0x18. The following figure shows the LSB of the V775 as a function of the Full Scale Register setting. This is a "typical" case; the curve may change slightly from board to board due to the tolerance of the components (about 10%).

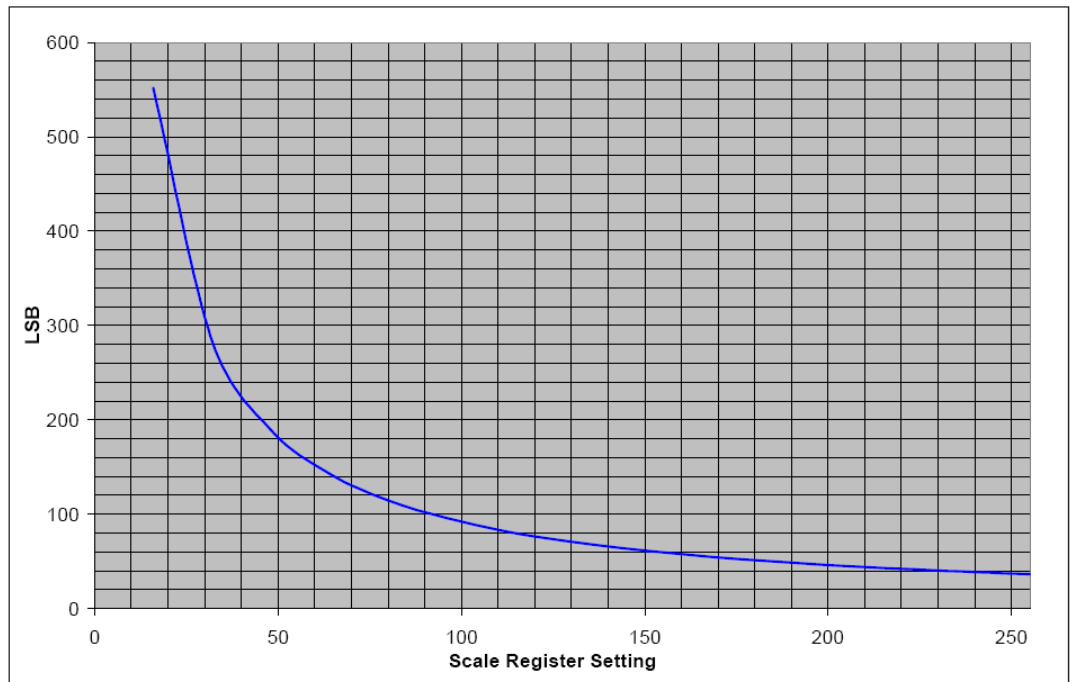

Fig. 4.33: LSB Vs. Full Scale Range Register setting

4.34. R Memory Test Address Register

(Base Address + 0x1064 write only)

This register contains the address of the output buffer from which data can be read for the memory test.

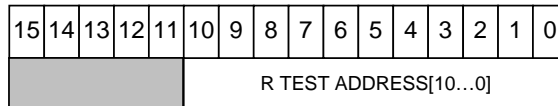

Fig. 4.34: R Memory Test Address Register

N.B.: The output buffer is a FIFO, so the read address (R Test Address Register) must be different from the write address (W Test Address Register).

4.35. SW Comm Register

(Base Address + 0x1068 write only)

A write access to this dummy register causes a conversion for test purposes.

4.36. Slide constant Register

(Base Address + 0x106A read/write)

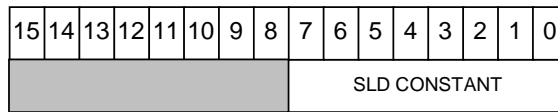

Fig. 4.35: Slide Constant Register

This register contains a 8-bit value corresponding to the constant to which is set the sliding scale DAC when the sliding scale is disabled by means of the SLD_ENABLE bit of the Bit Set 2 Register (refer to § 4.25).

4.37. AAD Register

(Base Address + 0x1070 read only)

This register contains the value converted by the ADC of the Block A (refer to the block diagram of Fig. 1.2).

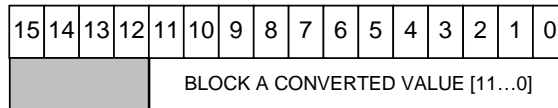

Fig. 4.36: AAD Register

4.38. BAD Register

(Base Address + 0x1072 read only)

This register contains the value converted by the ADC of the Block B (Refer to the block diagram of Fig. 1.2).

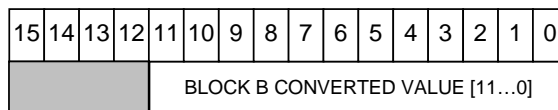

Fig. 4. 37: BAD Register

4.39. Thresholds Memory

(Base Address + 0x1080 ÷ 0x10BE read/write)

This register contains the low threshold and kill option for each channel. The address is different for each channel (V775: ch0 → 0x1080, ch1 → 0x1082, ..., ch30 → 0x10BC, ch31 → 0x10BE; V775N: ch0 → 0x1080, ch1 → 0x1084, ..., ch14 → 0x10B8, ch15 → 0x10BC).

Each threshold register is as shown in the figure:

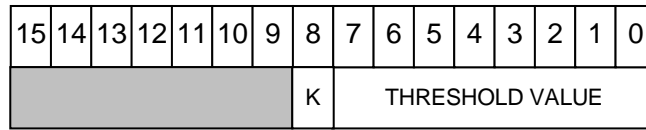

Fig. 4. 38: Threshold Register

KILL (K): allows to abort memorisation of the data from the relevant channel.
 = 0 channel data are memorised;
 = 1 channel data memorisation is aborted.

THRESHOLD VALUE: this is a 8-bit value which is compared with the 8MSB of the 12-bit value to be memorised.

Default settings are not defined.

Please note that the KILL option can be used to disable some channels.

N.B.: the threshold values are reset only with a hardware reset and when the board is switched off.

4.40. ROM memory

(Base Address + 0x8000 ÷ 0xFFFF, read only)

It contains some useful information according to the table below, such as:

- **OUI:** manufacturer identifier (IEEE OUI);
- **Version:** purchased version of the Mod.V775 (in the table: Mod.V775AA);
- **Board ID:** Board identifier (775);
- **Revision:** hardware revision identifier;
- **Serial MSB:** serial number (MSB);
- **Serial LSB:** serial number (LSB).

Table 4.5: ROM Address Map for the Model V775

Description	Address	Content (*)
OUI MSB	0x8026	0x00
OUI	0x802A	0x40
OUI LSB	0x802E	0xE6
Version	0x8032	0x11
BOARD ID MSB	0x8036	0x00
BOARD ID	0x803A	0x03
BOARD ID LSB	0x803E	0x07
Revision	0x804E	0x00
Serial MSB	0x8F02	0x00
Serial LSB	0x8F06	0x02

(*) the example of content for the relevant register refers to the Mod.V775AA (serial number: 2; hardware revision: 0).

5. Operating modes

5.1. Installation

The V775 board must be inserted in a V430 VME 6U crate if the purchased version is equipped with a PAUX connector. If the version does not have the PAUX connector, it can be inserted into a standard VME 6U crate. Refer to Table 1.1 for details on the various versions. Please note that some versions of the board support live insertion/extraction into/from the crate, i.e. it is possible to insert or extract them from the crate without turning the crate off. Moreover, it is possible to switch the board off by the relevant PWR switch (see § 3.5.2) without cutting the interrupt chain off.



CAUTION

ECL INPUTS ARE SUSCEPTIBLE TO DAMAGE FROM ESD (ELECTROSTATIC DISCHARGE). TO PREVENT THE RISK OF DAMAGING, THE USER SHOULD NEUTRALIZE ANY STATIC ELECTRIC CHARGE BUILT UP ON THE BODY (e.g. TOUCHING AN EARTHED OBJECT) BEFORE HANDLING THE ECL CONNECTORS



CAUTION

ALL CABLES MUST BE REMOVED FROM THE FRONT PANEL BEFORE EXTRACTING THE BOARD FROM THE CRATE!

5.2. Power ON sequence

To power ON the board follow this procedure:

1. insert the V775 board into the crate: as the board is inserted, the OVC PWR green LED lights up indicating that the board is powered;
2. if the board supports "live insertion" and the TERM LED, BUSY LED and DRDY LED are off, press the flush plunger PWR micro-switch on the front panel by inserting into it a pin: as this switch is pressed, the TERM LED lights up orange,

the BUSY LED becomes red and the DRDY LED becomes yellow; this indicates that the board is turned on and is configuring;
if the TERM LED, BUSY LED and DRDY LED are on, it means that the board is already ON and is configuring (the board can be on or off as it is inserted into the crate, depending on how it was when it was extracted);

3. after a short time the BUSY and DRDY LEDs will light off and the TERM LED will become either red or green or off, according to the status of the terminations on the PCB of the board: this indicates that the board is ready to acquire data.

N.B.: if the OVC PWR LED becomes orange instead of being green, there is an overload and the over-current protection is now running. In order to acquire data, it is necessary to remove the overload source, then turn the board off and switch it on again. Sometimes, it may happen that the OVC PWR LED is orange as soon as the board is inserted in the crate: this is due to the fact that the board has been just misplaced into the crate. In this case, extract the board and insert it again into the crate.

5.3. Power ON status

At power ON the module is in the following status:

- the Event Counter is set to 0;
- the Output buffer is cleared;
- the Read and Write Pointer are cleared (i.e. Buffer 0 is pointed);
- the Interrupt Level is set to 0x0 (in this case interrupt generation is disabled) and the Interrupt Vector is set to 0x0;
- the values in the threshold memory are not defined (see § 4.39);
- the MCST/CBLT address is set to 0xAA.

Moreover, all other registers marked in the column HR (Hardware RESET) in Table 4.2 are cleared or set to the default value.

At power on or after a hardware reset (see § 2.10) the module must thus be initialised.

5.4. Operation sequence

After the power ON sequence the module is in the status described above.

Please note that the threshold values are not defined after power ON and consequently before starting the operation of the module it is necessary to set a threshold value for each channel in the Threshold memory (refer to § 4.39).

If the module is not BUSY, a COM signal causes the following:

1. starts or stops the TAC depending on operating mode selection;
2. increments the event counter according to the user's settings (see § 2.8);
3. sets the BUSY output signal to 1 until the end of the conversion (if the MEB is not full).

If neither RESET nor FAST CLEAR occur (refer to § 2.10 and § 2.11) to abort the Time to Amplitude Conversion, the control logic starts the following conversion sequence:

1. The outputs of the TAC sections are multiplexed and sampled;
2. The control logic checks if there are accepted data among the converted values, according to the user's settings (zero suppression, overflow suppression and KILL option: see § 2.4 and § 2.5):
 - a) if there are accepted data, these are stored in the active event buffer together with a Header and an EOB;
 - b) if there are no accepted data and the EMPTY PROG bit of the Bit Set 2 Register is set to 0 (default setting, see § 4.25), no data will be written in the output buffer.
 - c) if there are no accepted data and the EMPTY PROG bit of the Bit Set 2 Register is set to 1 (see § 4.25), the Header and EOB only will be written in the output buffer.
3. The TAC sections and the BUSY is cleared and the module is ready for the next acquisition.

5.5. Test Modes

Two different test modes can be enabled:

- **Random Memory Access Test Mode,**
- **Acquisition Test Mode,**

The first test mode operation is enabled via the Bit 0 of the Bit Set 2 Register and allows to write directly into the buffer.

The second test mode is enabled via the Bit 6 of the Bit Set 2 Register and allows to test the whole acquisition system by writing a set of 32 data in an internal FIFO which are then transferred to the output buffer at each COM pulse for the readout.

The test modes will be described in detail in the following subsections.

5.5.1. Random Memory Access Test Mode

This test mode allows the user to write and read a word in the output buffer.

To perform such test follow these steps:

1. Reset the board;
2. Set to 1 the Bit 0 of the Bit Set 2 Register (see § 4.25);
3. Write into the W Memory Test Address Register (see § 4.27) the 11-bit address where to write the test word;
4. Write the high and low part of the 32-bit test word respectively in the Test Word_High and Test Word_Low Registers (see § 4.28 and § 4.29). As the Test Word_Low register is accessed, the whole test word is written into the memory;
5. Write in the R Test Address Register (see § 0) the 11-bit reading memory address and read out the buffer; please note that this address must be different from the write address written in the W Memory Test Address Register.

N.B.: please note that the R Memory Test Address must be different from the W Memory Test Address at any step of the procedure. If the user tries to write an address in one of these registers that is equal to the address contained in the other register, write cycles (step 3. above) will not write the correct value.

5.5.2. Acquisition Test Mode

This test mode allows the User to simulate the real operation of the board without using any channel input signals but just writing the data into a FIFO via an appropriate register (Test Event Write Register, see § 4.31) and reading them after a COM signal.

To operate the acquisition test follow these steps:

1. Reset the board;
2. Set to 1 the Bit 5 (VALID CONTROL) of the Bit Set 2 Register (see § 4.25);

3. Set to 1 the Bit 6 (TEST ACQ) of the Bit Set 2 Register (see § 4.25); this action selects the Acquisition Test Mode and resets the write pointer in the FIFO;
4. Set to 0 the Bit 6 (TEST ACQ) of the Bit Set 2 Register by using the Bit Clear 2 Register (see § 4.25 and § 4.26); this action resets the read pointer in the FIFO and releases the write pointer;
5. Write 32 data words (each word consisting of a 13-bit word, corresponding to the ADC converted value, + the overflow bit, see § 4.31) in the Test Event Write Register (Base Address + 0x103E). These 32 data constitute the event to obtain as output of the 32 channels. The 32 test data must be written in this FIFO in the same order as they will be read from the output buffer, that is:
 - test datum for the channel 0
 - test datum for the channel 16
 - test datum for the channel 1
 -
 - test datum for the channel 30
 - test datum for the channel 15
 - test datum for the channel 31

N.B.: please note that the user must write at least and not more than 32 test words. Actually, since the words are written in a circular FIFO, if the user writes less than 32 words, some words will be not defined; on the other hand, if the user writes more than 32 words, some words will be overwritten.

6. Set to 1 the Bit 6 (TEST ACQ) of the Bit Set 2 Register (see § 4.25); this action resets again the write pointer in the FIFO and releases the read pointer;
7. Send a set of COM input signals: at each COM signal the data previously written in the FIFO will be transferred to the output buffer. The data will be read via VME in the same order as they were written into the FIFO:
 - test data word for the channel 0
 - test data word for the channel 16
 - test data word for the channel 1
 -
 - test data word for the channel 30
 - test data word for the channel 15
 - test data word for the channel 31

N.B.: To operate in normal mode again, the Bit 6 of the Bit Set 2 Register must be set again to 0.

5.6. Block Transfer Mode

The module supports the Standard BLT32 and MBLT64 modes.

A standard readout in Block Transfer mode, for example, consists of a readout of the Header for the relevant event and a Block Transfer readout of the number of data words relative to the event (the number of data words referring to the event is the CNT number in the Header, see § 4.5).

A more efficient readout in Block Transfer mode can be performed by using the BLOCK END and BERR-ENABLE bits of the Control Register 1 (see § 4.13).

Some examples of this type of readout in Block Transfer mode are as follows:

Example A: BLOCK END = 0, BERR_ENABLE = 0;
A Block Transfer readout of 32x34 words (32 events max., each event 34 words max.) allows the readout of all data stored in the buffer: as the buffer is empty, the module will send only not valid data.

Example B: BLOCK END = 0, BERR_ENABLE = 1;
A Block Transfer readout of 32x34 words (32 events max., each event 34 words max.) allows the readout of all events stored in the buffer: as the buffer is empty, a BERR is generated.

Example C: BLOCK END = 1, BERR_ENABLE = 0;
A Block Transfer readout of 34 words (each event 34 words max.) allows the readout of one complete event: after the readout of the EOB the module will send only not valid data.

Example D: BLOCK END = 1, BERR_ENABLE = 1;
A Block Transfer readout of 34 words (each event 34 words max.) allows the readout of one complete event: as the EOB is encountered, a BERR is generated.

N.B.: Please note that, according to the VME standard, a Block Transfer readout can be performed with 256 read cycles maximum: as a consequence, a readout with a greater number of read cycles may require more BLT operations.

This limit is not due to the board itself but only to the VME standard: if it is possible to disable or delay the timeout of the BUS Timer (BTO(x)), a Block Transfer readout with more than 256 read cycles can be performed as well.

5.7. Advanced Setting and Readout Modes

Chained Block Transfer (CBLT) and Multicast (MCST) operations allow to enhance the set and readout time of the 32 channels. These operations allow accessing several boards at the same time: CBLT operations are used for reading cycles only, while MCST operations are used for write cycles only. For further details on the CBLT/MCST addressing mode please refer to § 4.1.4 and § 4.1.5.

In order to perform CBLT and MCST operations, the higher Base Address bits of all the involved modules (i.e. bits 31 to 24) must be set in common to all boards via the MCST/CBLT Address Register (see § 4.7). This means that all boards must have the same setting on bits 31 to 24.

The resulting MCST (CBLT) Base Address for all boards is:

MCST (CBLT) Base Address = 0xNN000000,

Once the addresses have been set, the first and last board in a chain must have, respectively, only the FIRST_BOARD and only the LAST_BOARD bit set to 1 in the MCST Control Register (see § 4.7). Conversely, all intermediate boards must have both the FIRST_BOARD and the LAST_BOARD bits set either to 1 or to 0.

5.7.1. Chained Block Transfer Mode

Once set the address of the boards as described in the above section, the boards can be accessed in Chained Block Transfer mode (CBLT, see [5]). This mode allows for sequential readout of a certain number of contiguous boards in a VME crate. A CBLT access is allowed with the BLT32 and MBLT64 address modifiers only (CBLT32 and CBLT64 accesses respectively).

N.B.: The CBLT operation can be performed only for the readout of the Multi-Event Buffer: its address in CBLT mode corresponds to the set of offsets listed in

Table 4.3 to be added to the address, common to all boards, set by the user via the MCST/CBLT Address Register which contains the most significant bits of the address (see § 4.7).

The user must perform a number of CBLT accesses that allows for the readout of all data in all boards of the chain in all possible occupancy conditions. E.g.: if the user has a chain of 10 boards, the total number of words for a given event lies between 0 (i.e. no data) and $34 \times 10 = 340$ 32-bit words (i.e. each board has an event, each event consists of a Header + 32 data + End of Block). In the latter case, in order to be sure that a BERR is generated, the user must thus perform 11 CBLT accesses of 34-word each.

In CBLT32 mode the first board of the chain starts sending data (if there are any, i.e. if it is not purged, see § 4.12); as it has sent all data and the EOB is met, the board becomes purged, i.e. the relevant bit (PURGED) of the Status Register 1 is set to 1. This implies that the board will not be involved in the CBLT access any more since it has already sent all the required data. At this point the IACKOUT line is asserted and the next board, if not purged, starts sending data. As the last board receives the token and is purged, it asserts a BERR which acts as a data readout completion flag.

In CBLT64 mode the accesses work as in the CBLT32 one, except for the fact that the address is acknowledged during the first cycle and consequently a DTACK is asserted at least once.

In CBLT mode the Read Pointer must be incremented automatically: if the AUTOINC_ENABLE bit is set to 1 in the Bit Set 2 Register (see § 4.25), the Read Pointer is automatically incremented with the readout of the End Of Block word of each board; if the AUTOINC_ENABLE bit is set to 0, the Read Pointer is not automatically incremented and only the Header of the first word is read.

N.B.: Please note that, according to the VME standard, a Chained Block Transfer readout can be performed with 256 read cycles maximum: as a consequence, a readout with a greater number of read cycles may require more CBLT operations.

This limit is not due to the board itself but only to the VME standard: it is actually possible to performed a CBLT readout with more than 256 read cycles if the timeout of the BUS Timer (BTO(x)) is disabled or delayed.

If the latter action is not allowed and the CBLT readout stops before having read all data, the new CBLT cycle will start from where the token was left in the previous cycle: this goes on until the last board is reached and all data read, so that a BERR is generated.

5.7.2. Multicast Commands

Once set the address of the boards as described in § 5.7, the boards can be accessed in Multicast Commands (MCST) mode. The MCST mode allows to write in the registers of several boards at the same time by accessing a dummy Address only once. The latter is composed by the MCST Base Address plus the offset of the relevant register, according to the list shown in Table 4.4. Refer to § 4.1.4 for details on MCST addressing mode. MCST access can be meaningless (even if possible) for the setting parameters depending on the individual channel characteristics.

N.B.: the MCST/CBLT Address Register must NEVER be accessed in MCST mode since this can affect the CBLT and MCST operations themselves.

APPENDIX A

VME interface timing

A.1 VME Cycle timing in D16/D32 mode

The figure below reports the Data Select (DS0 or DS1) - Data Acknowledge (DTACK) VME cycle in D16 mode and relative timing.

The theoretical minimum duration of the VME cycle in D16/D32 mode is 120 + 60 ns.

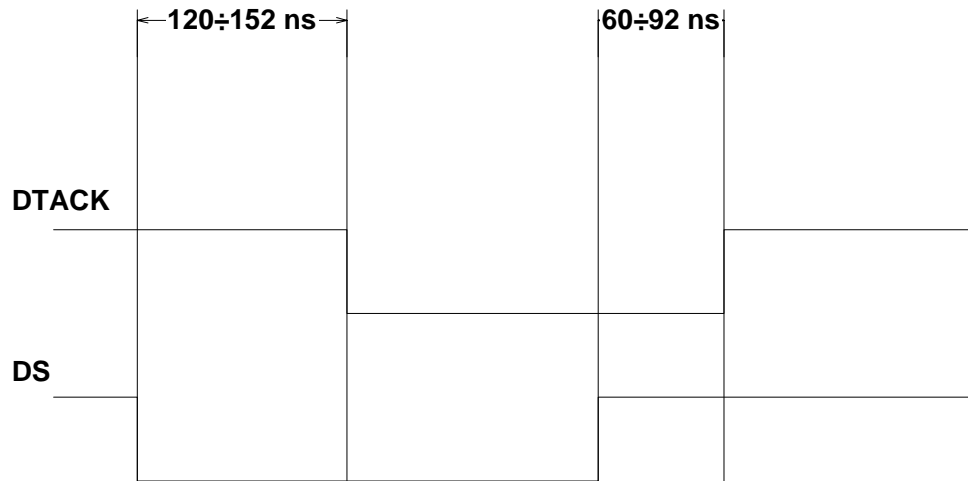

Fig. A.1: VME cycle timing in D16 mode

A.2 VME Cycle timing in BLT / CBLT mode

The figure below reports the Data Select (DS0 or DS1) - Data Acknowledge (DTACK) VME cycle in BLT / CBLT mode and relative timing.

The theoretical minimum duration of the VME cycle in BLT/CBLT mode is 60 + 15 ns.

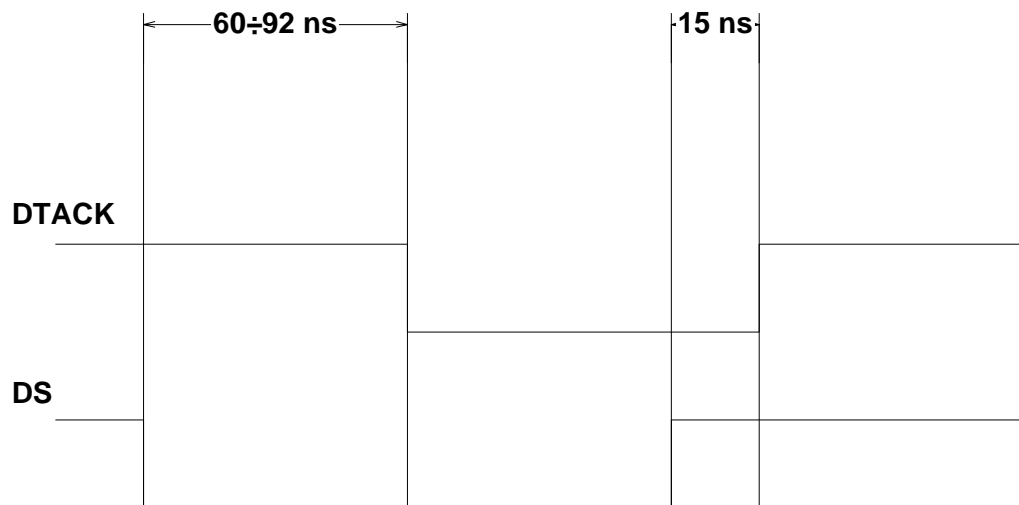

Fig. A.2: VME cycle timing in BLT/CBLT mode

A.3 VME Cycle timing in MBLT / CBLT64 mode

The figure below reports the Data Select (DS) - Data Acknowledge (DTACK) VME cycle in MBLT / CBLT64 mode and relative timing.

The theoretical minimum duration of the VME cycle in MBLT/CBLT64 mode is $120 + 15$ ns.

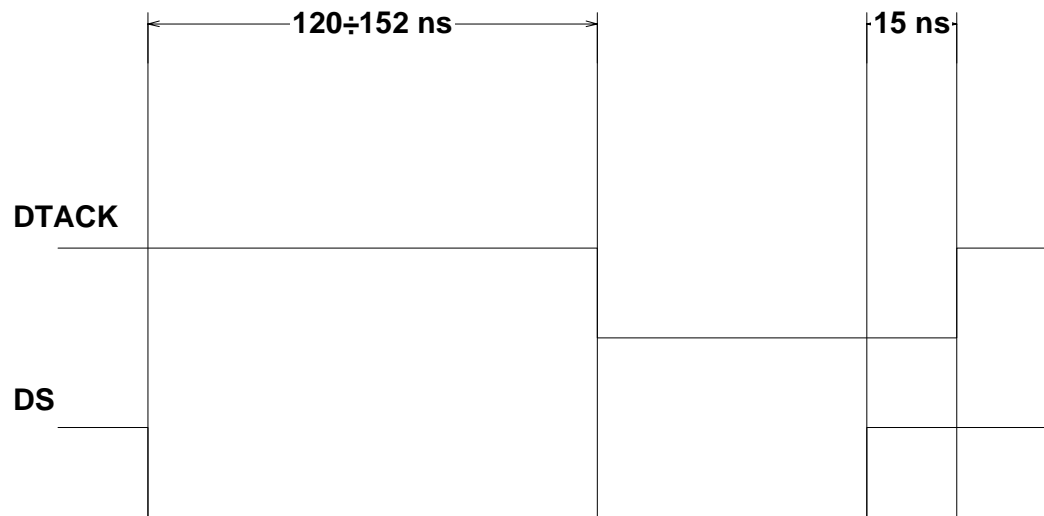

Fig. A.3: VME cycle timing in MBLT/CBLT64 mode

6. References

- [1] C. Cottini, E. Gatti, V. Svelto, "A new method of analog to digital conversion", NIM vol. 24 p.241, 1963.
- [2] C. Cottini, E. Gatti, V. Svelto, "A sliding scale analog to digital converter for pulse height analysis", in Proc. Int. Symp. Nuclear, Paris, Nov. 1963.
- [3] G. Bianchetti et al., "Specification for VMEbus CRATE Type V430", CERN-EP, January 1990.
- [4] -VME64 extensions draft standard, Vita 1.1-199x, draft 1.8, June 13,1997.
- [5] -VMEBus for Physics Application, Recommendations & Guidelines, Vita23-199x, draft 1.0, 22 May 1997.

Both documents are available from URL: <http://www.vita.com>