

# ZUP SERIES

Programmable CVCC 200W ~ 800W 19Model

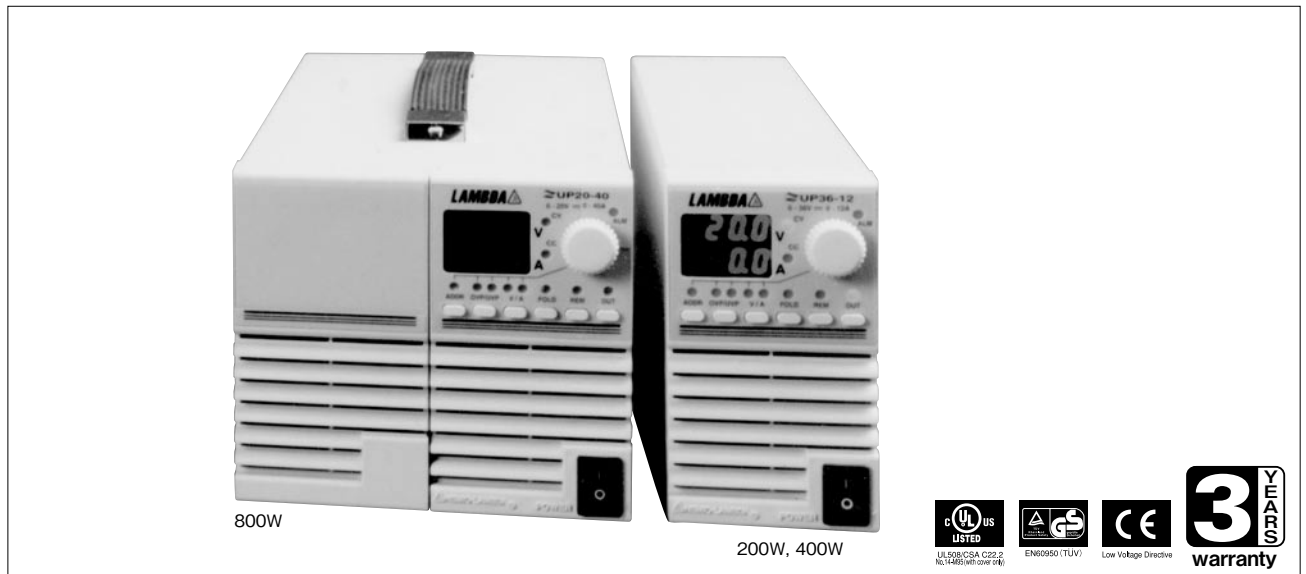

## ■ Features

- Constant Voltage/Constant Current
- Built-in RS232 & RS485 Interface
- An embedded Microprocessor controller
- Digital Encoder Knob
- Software Calibration
- Last Setting Memory
- Parallel Operation (Master/Slave) Active Current Sharing
- External Voltage or Resistance Programming
- Voltage up to 120V, Current up to 132A
- Active Power Factor Correction: 99%
- 85~265Vac Universal Input Voltage
- 19" Rack Mounted ATE and OEM
- Worldwide Safety Agency Approvals
- CE Mark for LVD and EMC Regulation

## ■ Model naming method

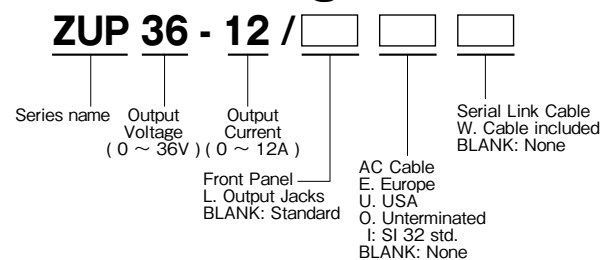

## ■ Applications



## ■ Conformity to RoHS Directive

This means that, in conformity with EU Directive 2002/95/EC, lead, cadmium, mercury, hexavalent chromium, and specific bromine-based flame retardants, PBB and PBDE, have not been used, except for exempted applications.

## ■ Product Line up

Output Voltage	200W		400W		800W	
	Output Current	Model	Output Current	Model	Output Current	Model
0-6V	0-33A	ZUP6-33	0-66A	ZUP6-66	0-132A	ZUP6-132
0-10V	0-20A	ZUP10-20	0-40A	ZUP10-40	0-80A	ZUP10-80
0-20V	0-10A	ZUP20-10	0-20A	ZUP20-20	0-40A	ZUP20-40
0-36V	0-6A	ZUP36-6	0-12A	ZUP36-12	0-24A	ZUP36-24
0-60V	0-3.5A	ZUP60-3.5	0-7A	ZUP60-7	0-14A	ZUP60-14
0-80V	0-2.5A	ZUP80-2.5	0-5A	ZUP80-5	—	—
0-120V	0-1.8A	ZUP120-1.8	0-3.6A	ZUP120-3.6	—	—

ZUP

# ZUP Specifications

ITEMS/UNITS		MODEL	ZUP6-33	ZUP6-66	ZUP6-132	ZUP10-20	ZUP10-40	ZUP10-80	ZUP20-10
OUTPUT VOLTAGE	(*1)	V	0-6			0-10			
OUTPUT CURRENT	(*2)	A	0-33	0-66	0-132	0-20	0-40	0-80	0-10
RATED OUTPUT POWER		W	198	396	792	200	400	800	200
CONSTANT VOLTAGE	LOAD REGULATION		0.005%+2mV From No load to Full load, constant input voltage.						
	LINE REGULATION		0.005%+1mV From 85-132VAC or 170-265VAC, constant load.						
	RMS RIPPLE (5Hz-1MHz Bandwidth)	mV	5	5	8	5	5	8	5
	RIPPLE (pk to pk) (20MHz Bandwidth)	mV	50	50	100	50	50	90	50
	RECOVERY TIME	(*3)	mS	1			0.5		
	TEMPERATURE COEFFICIENT		30ppm/°C from rated voltage following 30-minute warm-up.						
	TEMPERATURE DRIFT		0.01%+2mV Change in output over 8-hour interval under constant line, load and ambient temp following 30-minute warm-up.						
	UP PROGRAMMING RESPONSE TIME (*4)	mS	50	50	60	50	50	60	50
DOWN PROGRAMMING	FULL LOAD	mS	50	50	50	50	50	50	50
RESPONSE TIME	NO LOAD	mS	250			350			
CONSTANT CURRENT	LOAD REGULATION (*5)		0.01%+5mA	0.01%+5mA	0.07%+10mA	0.01%+5mA	0.01%+5mA	0.07%+10mA	0.01%+5mA
	LINE REGULATION (*6)		0.01%+2mA	0.01%+2mA	0.01%+5mA	0.01%+2mA	0.01%+2mA	0.01%+5mA	0.01%+2mA
	RMS RIPPLE (5Hz-1MHz Bandwidth)	mA	50	100	200	25	50	100	15
	TEMPERATURE COEFFICIENT		100ppm/°C from rated current following 30-minute warm-up.						
TEMPERATURE DRIFT (*8)		0.02%+5mA	0.02%+5mA	0.05%+10mA	0.02%+5mA	0.02%+5mA	0.05%+10mA	0.02%+5mA	
PROGRAMMING (*9)	RESOLUTION		Better than 0.028% of rated output voltage						
	VOLTAGE ACCURACY		0.02%+5mV			0.02%+8mV			
	RESOLUTION		Better than 0.03% of rated output current						
CURRENT ACCURACY		0.4%+40mA							
OVERVOLTAGE PROTECTION (*10)	V		0-7.5			0-13			
HOLD-UP TIME			20mS At 100V/200VAC, rated output voltage and output current.						
DISPLAY	VOLTAGE		3 digits ( 6v; 20v; 36v; 60v; 80v); 3.5 digits ( 10v; 120v ) accuracy: 0.2% +/- 2 digits.						
	CURRENT		3.5 digits (132A); All others 3 digits, accuracy: 0.5% +/- 3 digits.						
	STATUS		CV/CC, Alarm, Fold, Local/Remote, On/Off.						
OUTPUT PROTECTIONS			Over Voltage, Over Temperature, Foldback.						
INPUT	INPUT VOLTAGE (*11)		85-265Vac Continuous, 47-63Hz						
	INPUT CURRENT (*12)	A	3.0/1.5	5.6/2.7	11.2/5.4	2.9/1.4	5.6/2.7	11.2/5.4	2.9/1.4
	INRUSH CURRENT ( 100/200V )	A	15/30 (*7)	15	30	15/30 (*7)	15	30	15/30 (*7)
	EFFICIENCY (*12)	%	69/72	74/77	74/77	73/77	79/82	77/81	74/78
	INPUT CURRENT HARMONICS		Complies with EN61000-3-2, Class A						
POWER FACTOR (TYP)		0.99 at 100/200Vac, 100% load.							
ENVIRONMENT	OPERATING TEMPERATURE		0 to 50 °C ; 100% Load.						
	OPERATING HUMIDITY		30-90% RH ( No dewdrop ).						
	STORAGE TEMPERATURE		-20 to 70 °C						
	STORAGE HUMIDITY		10 - 95% RH (No dewdrop).						
MECHANICAL	VIBRATION		10-55Hz, Amplitude (sweep 1 min ) 2G, X, Y, Z, When mounted with mounting screws.						
	SHOCK		Less than 20G						
	WEIGHT	Kg	2.9	3.2	5.8	2.9	3.2	5.8	2.9
	SIZE (W x H x D)	mm	200W and 400W units: 70 x 124 x 350. 800W units: 140 x 124 x 350 (Refer to outline drawing)						
EXTERNAL CONTROL FUNCTIONS	OUTPUT ON/OFF		By TTL Signal or Dry Contact (Refer to instruction manual).						
	OUTPUT GOOD		Open collector (Refer to instruction manual).						
	OUTPUT VOLTAGE PROGRAMMING		By Voltage ( 0-4V ) or by Resistance ( 0-4K ) (Refer to instruction manual).						
	OUTPUT CURRENT PROGRAMMING		By Voltage ( 0-4V ) or by Resistance ( 0-4K ) (Refer to instruction manual).						
	REMOTE SENSING		Maximum 0.5V drop on each load wire for model up to 60V and 2V for the 80V, 120V models						
COMMUNICATION INTERFACE		RS232 and RS485 Built-in, IEEE488 Optional.							
APPROVALS	SAFETY STANDARDS		UL3111-1, EN61010-1						
	EMC STANDARDS		EN61326-1, IEC 61326-1, FCC part 15 (class A).						
CONDUCTED EMI		EN55022-B, FCC-B, VCCI-2							
RADIATED EMI		EN55022-A, FCC-A, VCCI-1							
SERIES OPERATION		Up to 2 units (Refer to instruction manual).							
PARALLEL OPERATION		Master - Slave method; up to 5 units (Refer to instruction manual).							
COOLING		Forced air by blower fan (Blower fan is mounted within unit).							
WITHSTAND VOLTAGE		Input - Chassis...2.0kVAC 1 min, Input - Output...3.0kVac 1 min, Output - GND...500VAC 1 min.							
ISOLATION RESISTANCE		More than 100MOhm at 25 °C and 70% R.H.							

(\*1) Minimum voltage is guaranteed to maximum 0.2% of the rated output voltage.

(\*2) Minimum current is guaranteed to maximum 0.4% of the rated output current.

(\*3) Time for recovery to within +/-50mV against current change of 50% to 100%.

(\*4) From zero volts to full scale , resistive load and current setting at maximum.

(\*5) From no load to full load , constant input voltage. (Measure with JEITA RC-9131 probe.)

(\*6) From 85~132Vac or 170~265Vac constant load.

(\*7) At cold start Ta=25 °C.

(\*8) Change in output over 8 hour interval constant line, load and ambient temperature following 30-minutes warm-up.

(\*9) Given for control of the output via the serial communication or via front panel controls.

(\*10) Inverter shut down method, manual reset (OVP will shut down output)

(\*11) For cases where conformance to various safety specs. (UL, IEC, etc.) are required, to be described as 100-240VAC (50/60Hz) on name plate.

(\*12) At 100V/200V and Maximum Output Power. - When forced air cooling, refer to derating curve.

ZUP20-20	ZUP20-40	ZUP36-6	ZUP36-12	ZUP36-24	ZUP60-3.5	ZUP60-7	ZUP60-14	ZUP80-2.5	ZUP80-5	ZUP120-1.8	ZUP120-3.6
0-20		0-36			0-60			0-80		0-120	
0-20	0-40	0-6	0-12	0-24	0-3.5	0-7	0-14	0-2.5	0-5	0-1.8	0-3.6
400	800	216	432	864	210	420	80	200	400	216	432
									0.005%+4mV		
									0.005%+2mV		
5	5	5	5	5	5	5	5	20	20	20	20
50	80	50	50	70	50	50	60	70	70	80	80
0.2		0.2			0.2			0.2		0.2	
400		500			750			800		1000	
50	60	50	50	60	50	50	60	100	100	100	100
50	50	50	50	50	50	50	70	60	60	80	80
0.01%+5mA	0.07%+10mA	0.01%+5mA	0.01%+5mA	0.07%+10mA	0.01%+5mA	0.01%+5mA	0.07%+10mA	0.01%+5mA	0.01%+5mA	0.01%+5mA	0.01%+5mA
0.01%+2mA	0.01%+5mA	0.01%+2mA	0.01%+2mA	0.01%+5mA	0.01%+2mA	0.01%+2mA	0.01%+5mA	0.01%+2mA	0.01%+2mA	0.01%+2mA	0.01%+2mA
30	60	7.5	15	30	5	10	20	5	5	5	5
0.02%+5mA	0.05%+10mA	0.02%+5mA	0.02%+5mA	0.05%+10mA	0.02%+5mA	0.02%+5mA	0.05%+10mA	0.02%+5mA	0.02%+5mA	0.02%+5mA	0.02%+5mA
0.02%+12mV		0.02%+20mV			0.02%+35mV			0.02%+50mV		0.02%+80mV	
0-24		0-40			0-66			0-88		0-132	
5.6/2.7	11.2/5.4	2.9/1.4	5.6/2.7	11.2/5.4	2.9/1.4	5.6/2.7	11.2/5.4	2.6/1.3	4.9/2.4	2.9/1.4	5.3/2.6
15	30	15/30 (*7)	15	30	15/30 (*7)	15	30	15/30 (*7)	15	15/30 (*7)	15
79/83	79/82	76/80	80/84	80/84	75/79	80/84	80/84	78/82	83/87	78/82	82/86
3.2	5.8	2.9	3.2	5.8	2.9	3.2	5.8	2.9	3.2	2.9	3.2

Outline Drawing

[ZUP 200W/400W Units]

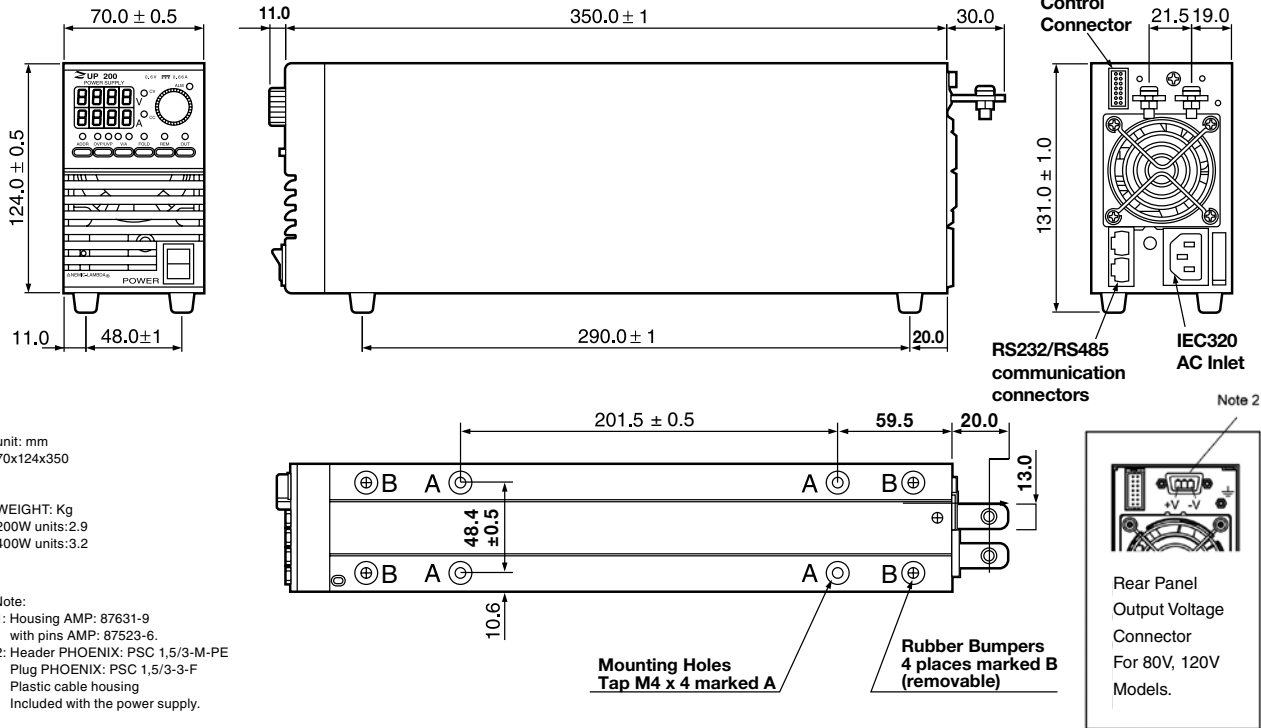

[ZUP 800W Unit]

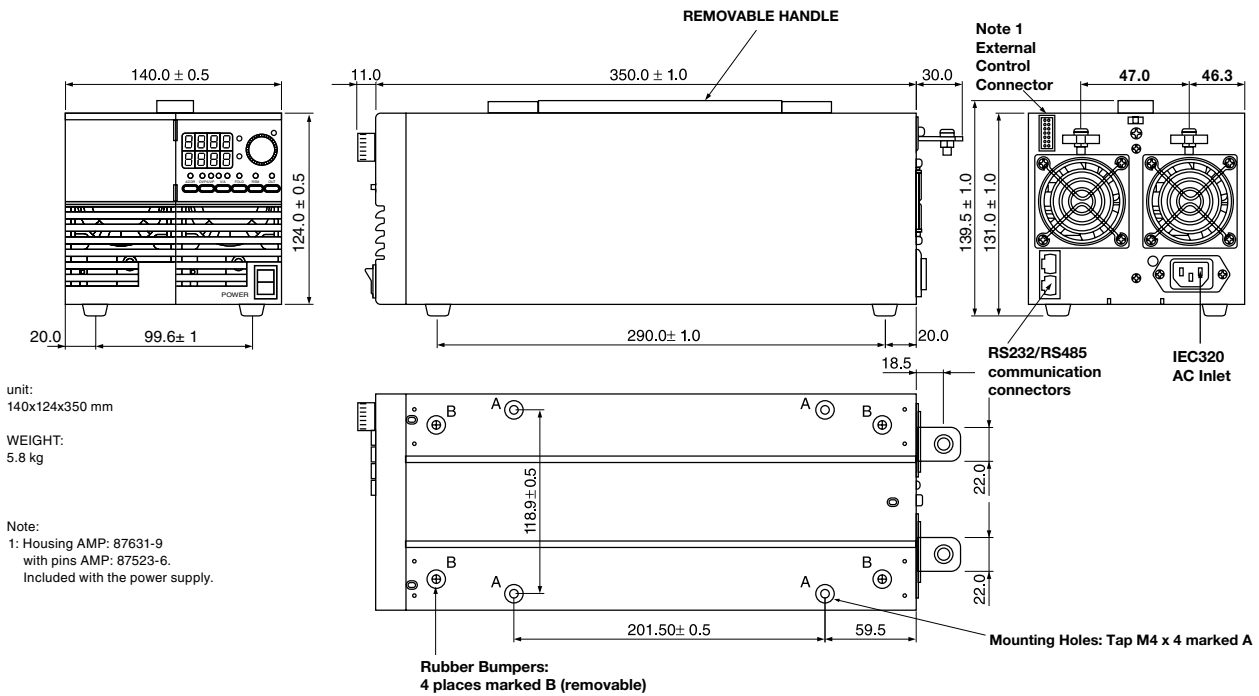

**Accessories / optional items** (refer to the attached diagram for appearance)

**Accessories**

**1. AC Cord Sets**

Three optional cords are possible according to order:

Region	AC Cord	Power Supply Connector	Wall Plug	P/N
				ZUP / J
Europe	10A / 250Vac L =2m	IEC320-C13	INT'L 7 / VII	ZUP / E
				ZUP / O



North America



Europe



SI-32 Standard

**2. Communication Cable**

RS232/RS485 cable is used to connect the power supply to the PC controller

Mode	PC connector	Communication cable	Power Supply Connector	P/N
RS232	DB-9	Shield Ground , L=1m	EIA / TIA-568A (RJ-45)	ZUP/NC401
RS232	DB-25	Shield Ground , L=1m	EIA / TIA-568A (RJ-45)	ZUP/NC403

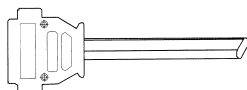
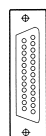

DB-25 (female connector)

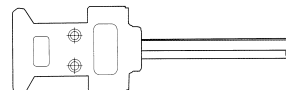
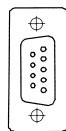

DB-9 (female connector)

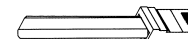

EIA/TIA (RJ-45)

**3. ZUP serial link cable**

Used to chain Power Supply to Power Supply from a serial communication bus

Mode	Communication cable	Power Supply Connector Remote IN / OUT	P/N
RS485	Shield Ground , L = 50cm	EIA / TIA-568A (RJ-45)	ZUP / W

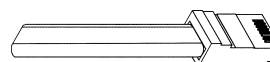
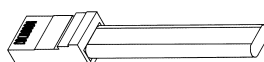

ZUP

## Options ( 200W, 400W, 800W Models )

### 1. FRONT PANEL OUTPUT JACKS

P/N: ZUP / L

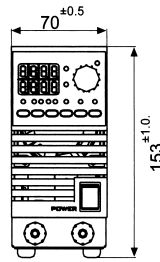

Outline Drawing: Physical Dimensions in mm.

ZUP 200W/400W Units: 70x153x405.9

ZUP 800W Units: 140x153x405.9

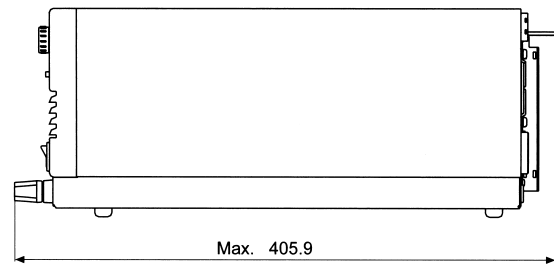

Up to 20A output current via front panel jacks.

### 2. ZUP ASSEMBLIES

Dual Output Packing 200W/400W models

P/N: ZUP/NL200

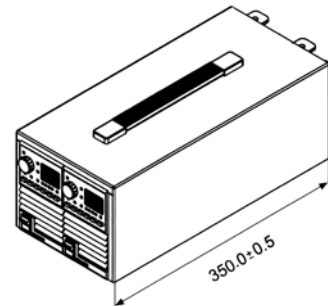
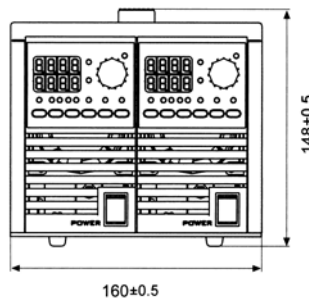

### 3. 19" RACK MOUNTED ATE AND OEM UP TO 2.4 KW

Up to six power units can be assembled into a 19 , 3U rack, kit P/N NL100.

In cases where the entire rack is not occupied with power units, NL101 blank panels can be installed.

P/N: ZUP/NL100

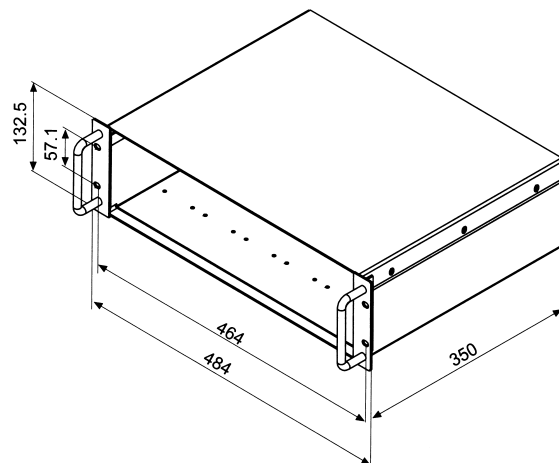
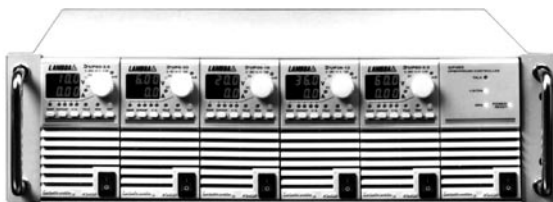

ZUP

# Application examples

## ZUP Configurations

### BENCH TOP POWER SUPPLY

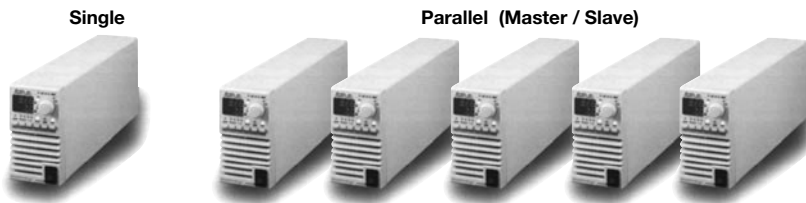

### PARALLEL OPERATION

Master - Slave method: Active current sharing up to 5 units.

### REMOTE PROGRAMMING VIA RS232

Up to 31 ZUP units can be controlled via RS232 interface.

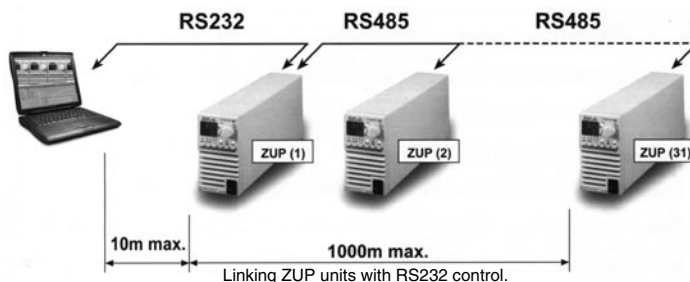

### REMOTE PROGRAMMING VIA RS485

Up to 31 ZUP units can be controlled via RS485 interface.  
For operation environments that require high noise immunity or long distance communication, it is recommended to use the built-in RS485 interface.

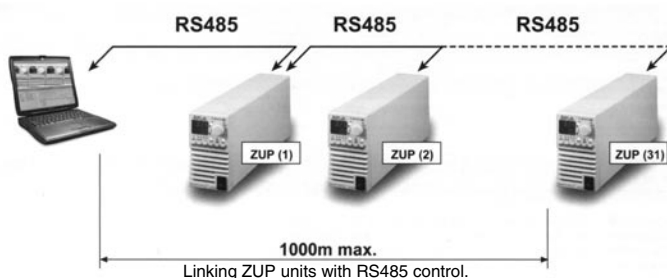

### Remote Programming Via GPIB.

#### GPIB⇔RS485 CONTROLLER

The GP485 is a high performance serial to GPIB Interface  
It enables a ZUP series with RS485 port to be a Talker, Listener, or controller on the GPIB

- \* Controls up to 31 ZUP units through a single GPIB address.
- \* Conforms to all versions of the IEEE488 standard, including IEEE488.2.
- \* 19 racking possibility.
- \* Application software - LabView, LabWindows.

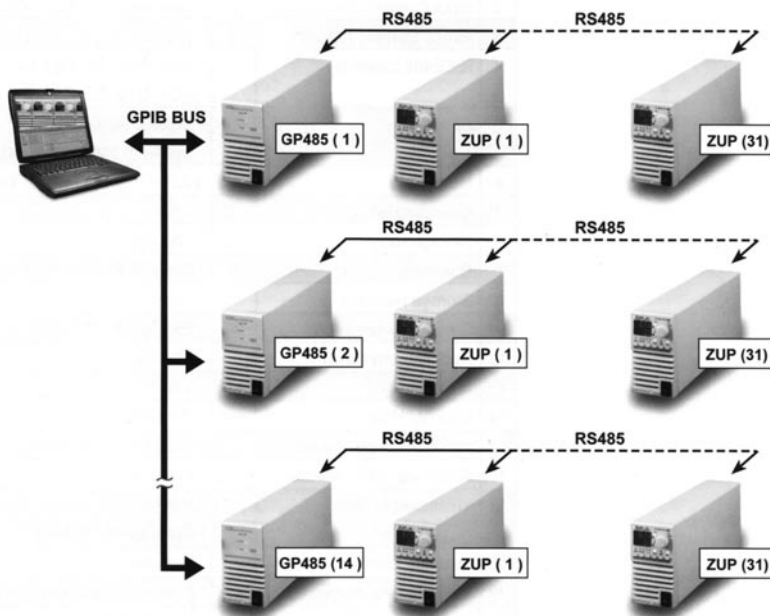

ZUP

## Rack Mounted ATE and OEM up to 2.4KW

Six units can be assembled into 19-inch rack / 3U high to meet your configuration requirements

### Power Modules Table

Module Type	200W	400W	800W
0 ~ 6V	33A	66A	132A
0 ~ 10V	20A	40A	80A
0 ~ 20V	10A	20A	40A
0 ~ 36V	6A	12A	24A
0 ~ 60V	3.5A	7A	14A
0 ~ 80V	2.5A	5A	
0 ~ 120V	1.8A	3.6A	
19"rack width	1 / 6 width	1 / 6 width	2 / 6 width

